

Please read these instructions completely before proceeding with installation

Air Spring Kit Parts List

Item	Description	Quantity
A	Air Sleeves	2
B	Upper Brackets	2
C	Lower Brackets	2
D	Elbow Fitting	2

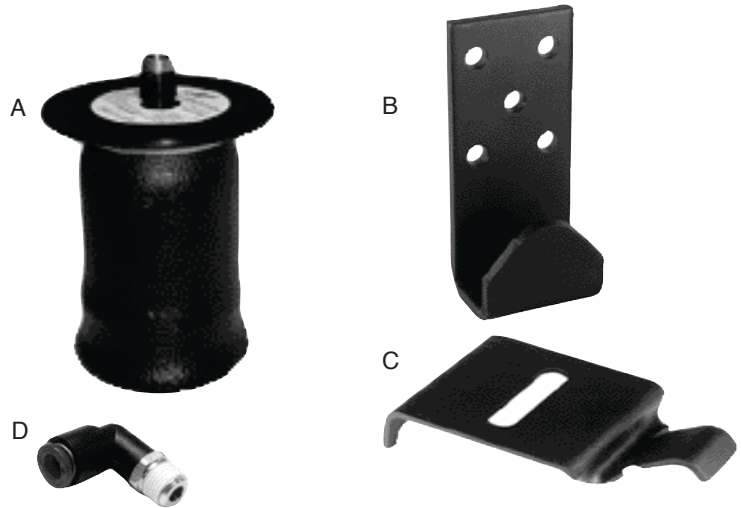

Bracket Attaching Hardware

Item	Description	Quantity
E	3/8"-16 U-Bolts	2
F	Clamp Bar	2
G	3/8" Nylock Nuts	4
H	3/8" Flat Washers	4
I	3/8" x 1" WHST	6

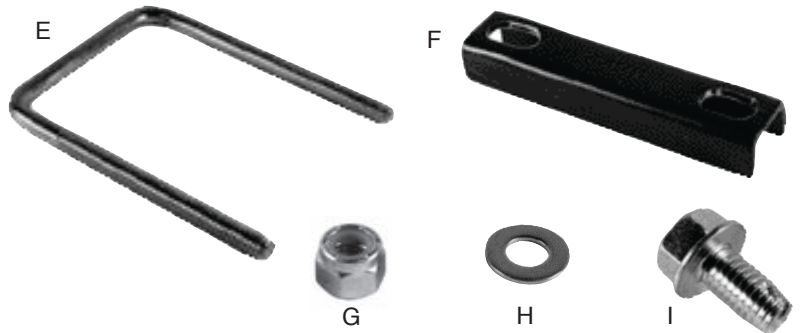

Air Spring Attaching Hardware

Item	Description	Quantity
J	1/2" x 7/8" Hex Head Bolts	2
K	3/4" Nylon Nut	2
L	1/2" Flat Washers	2



Air Line Assembly Parts List

Item	Description	Quantity
AA	Air Line Assembly	1
BB	Tie Strap	6
CC	Valve Caps	2
DD	5/16" Flat Washer	2
EE	Rubber Washer	2
FF	Small Star Washer	2
GG	5/16" Hex Nut	4
HH	Hose Clip	4
II	3/4" Self Tapping Bolt	4



Tools Needed

Standard and metric open end or box wrenches
Ratchet with $\frac{3}{8}$ ", $\frac{1}{2}$ ", & $\frac{9}{16}$ " deep well sockets
 $\frac{5}{16}$ " drill bit (very sharp)
 $\frac{7}{16}$ " & $\frac{9}{16}$ " Nut Drivers
Heavy Duty Drill
Torque Wrench

Hose Cutter, Razor Blade, or Sharp Knife
Hoist or Floor Jacks
Safety Stands
Safety Glasses
Air Compressor, or Compressed Air Source
Spray Bottle with Dish Soap/Water Solution



IMPORTANT: Your vehicle may be equipped with a rear brake proportioning valve. Any type of load assist product could affect brake performance. We recommend that you check with your dealer before installing this type of product. If your vehicle DOES NOT have a rear brake proportioning valve or is equipped with an anti-lock type brake system, installation of a load assist product will have NO EFFECT ON BRAKE SYSTEM PERFORMANCE.

IMPORTANT: Failure to maintain correct minimum pressure (or pressure proportional to load), bottoming out, overextension, or rubbing against another component will void the warranty.

DANGER: Compressed air can cause injury and damage to the vehicle and parts if it is not handled properly. For your safety, do not try to inflate the air springs until they have been properly secured to the vehicle.

I. Getting Started



Figure 1

1. Determine the Normal Ride Height. ***The Normal Ride Height is the distance between the bottom edge of the wheel-well and the center of the hub with the vehicle in the "as delivered" condition.*** In some cases, Normal Ride Height is not perfectly level.

- Remove unusual loads and examine your vehicle from the side to ensure it is on a level surface (Figure 1).
- If necessary (in cases where your leaf springs are sagging badly), use a jack to raise the rear end so that the vehicle achieves the original (as delivered) ride height.

2. Measure the distance between the center of the hub and the bottom edge of the wheel well (Figure 2). This is the Normal Ride Height. Enter the measurement below:

NORMAL
RIDE HEIGHT: _____ inches

3. **IMPORTANT: Be sure to follow the specific instructions for the correct vehicle application.**

4. See special installation instructions for the Dodge Durango.



Figure 2

II. Deciding Where To Mount

1. This kit will function in front or behind the axle. It is also permissible to stagger the air spring, if necessary, for fit. Where the kit is installed will depend on the type of vehicle presented.
2. For Mazda and Toyota applications, mount the air spring assembly **forward** of the axle housing.
3. For Chevy/GMC, Isuzu, Nissan, Oldsmobile, and Dodge applications, mount the air spring assembly **behind** the axle housing.
4. If your vehicle make is not listed above, set the air spring assembly on the leaf spring and check for clearance problems or obstructions that would prevent mounting the kit in that location.



Figure 3



Figure 4

III. Assembling the Air Spring Unit

1. Install 90 degree air swivel fitting (D) to the top of the air spring. Use an open end wrench being careful to tighten on the metal hex nut only. Tighten finger tight plus 1 and $\frac{1}{2}$ turns (Figure 3). Do not over tighten.

NOTE: This fitting is precoated with sealant.

2. Thread the attached fitting through the upper bracket (B) (Figure 4). Position the elbow towards the front or rear of the vehicle depending on which direction will allow easier access for the air line.
3. Slide the nylon nut (K) over the air fitting and onto the thread post, making sure that the flat side is up (Figure 5).
4. Tighten the nylon nut to secure the bracket. Hand tight is sufficient.

IMPORTANT: Ensure that the bracket is tight and flat to the roll plate on both sides.

5. Loosely attach the lower bracket (C) to the bottom of the air spring with $\frac{1}{2}$ " flat washer (L) and $\frac{1}{2}$ " Hex Head Cap Screw (J). See Figure 6.

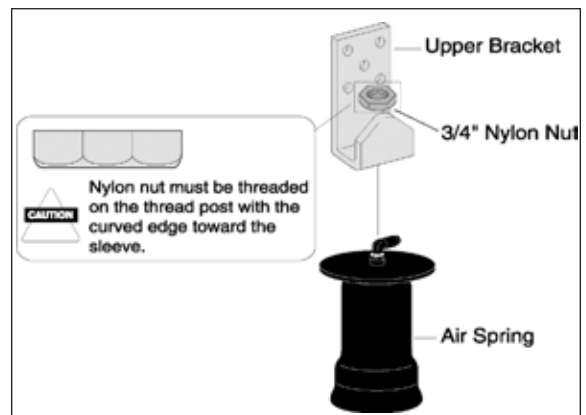

Figure 5

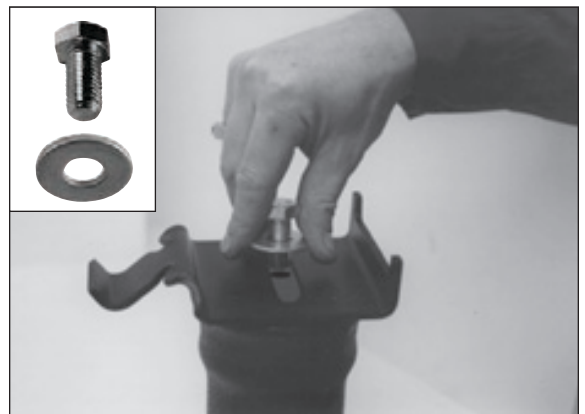

Figure 6

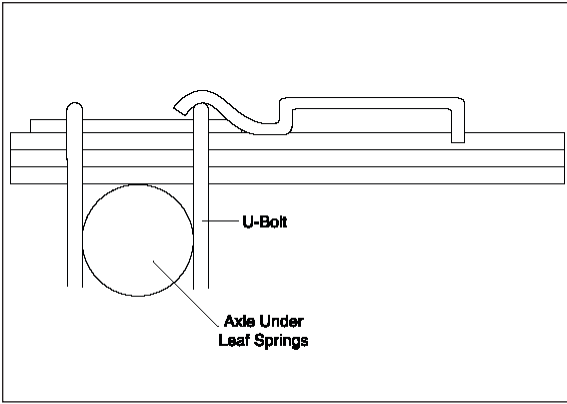

Figure 7

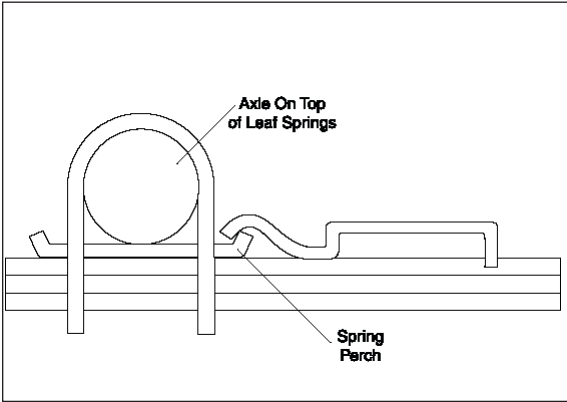

Figure 8

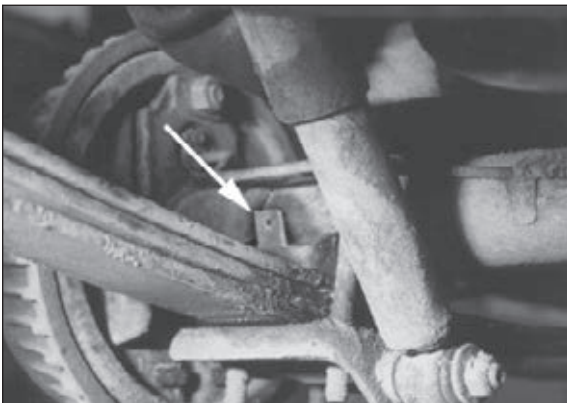

Figure 9

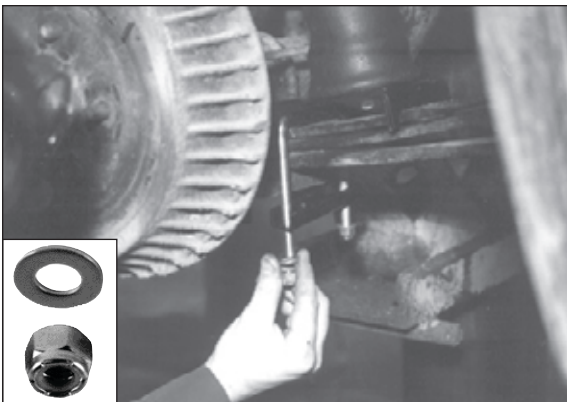

Figure 10

IV. Mounting the Lower Bracket

1. With the vehicle at normal ride height, set the bracket-air spring assembly on the leaf spring in the determined location (forward or behind). Set the assembly onto the leaf spring with the hook end of the lower bracket (C) over the spring perch or factory U-bolt. The hook end of the lower bracket must lock over the U-bolt or perch to avoid moving along the leaf spring. See Figure 7 and 8.

NOTE: For some Chevy/GMC S-Series Pickups and Blazer/Jimmy models, there may be a small tab located on the spring perch plate (Figure 9). It will be necessary to trim this tab off for proper placement of the lower bracket. This can be achieved by using a hack saw or die grinder.

2. Secure the lower bracket to the leaf spring using U-bolt (E), clamp bar (F), flat washers (H), and nylock nuts (G). See Figure 10. Tighten to 16 ft-lbs.

V. Locating the Upper Bracket

1. The upper bracket (B) must be parallel and perpendicular to the lower bracket (C). See Figures 11 and 12

2. **IMPORTANT: Dodge Durangos Only**

The Dodge Durango is equipped with an inner fenderwell liner. The first option is that the upper bracket can be positioned on the outside of the liner behind the axle (Durango Option 1 below). The second option is that the liner can be trimmed away as shown in the Durango Option 2 below.

3. Align the upper bracket so that the short leg of the upper bracket touches the bottom of the frame rail (Figures 13 and 14).

IMPORTANT: If the short leg of this bracket does not contact the frame rail, the warranty will be void.

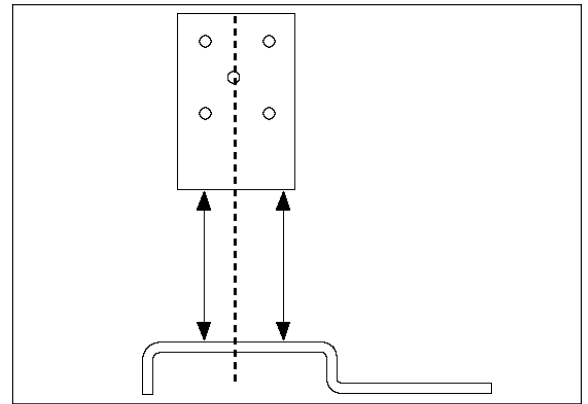

Figure 11

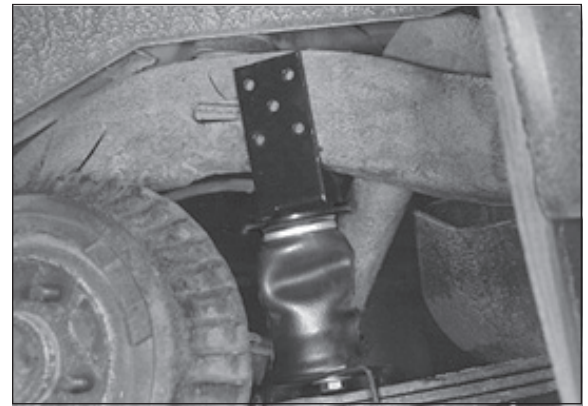
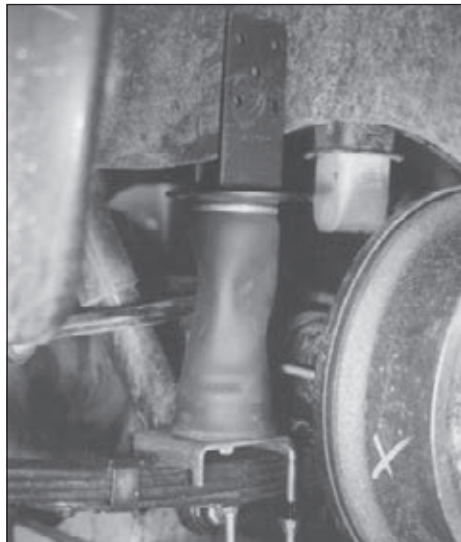

Figure 12



Durango Option 1

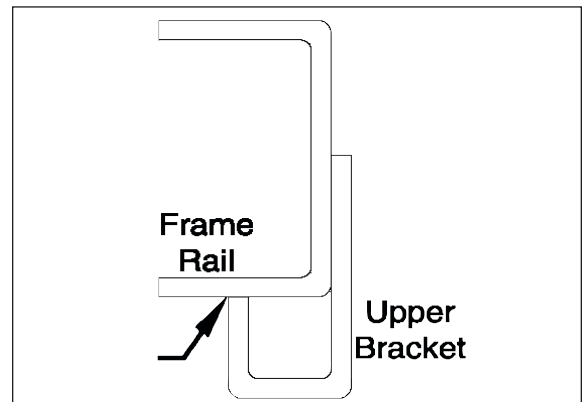
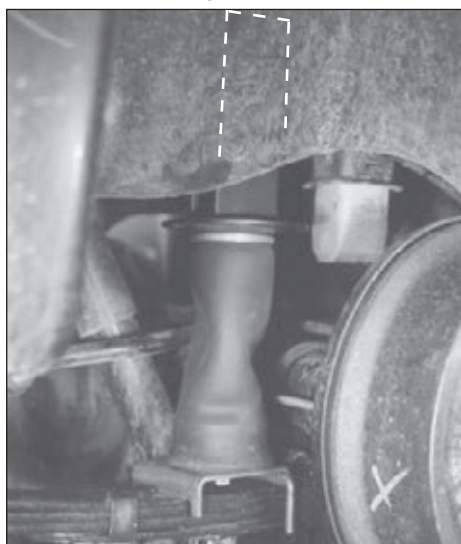

Figure 13



Durango Option 2

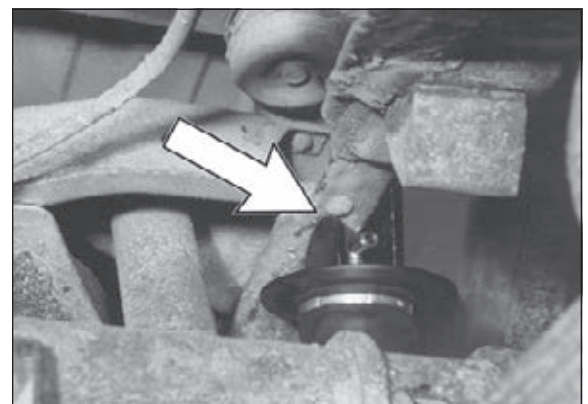

Figure 14



Figure 15

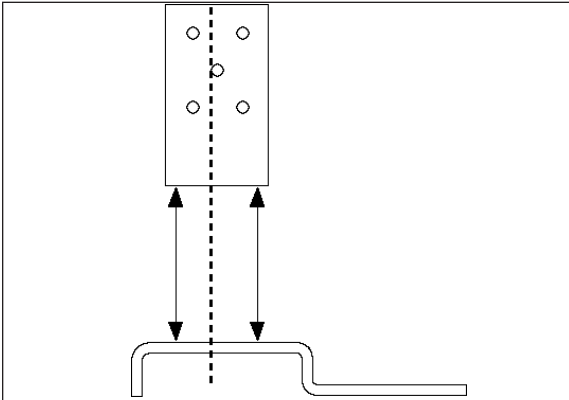

Figure 16

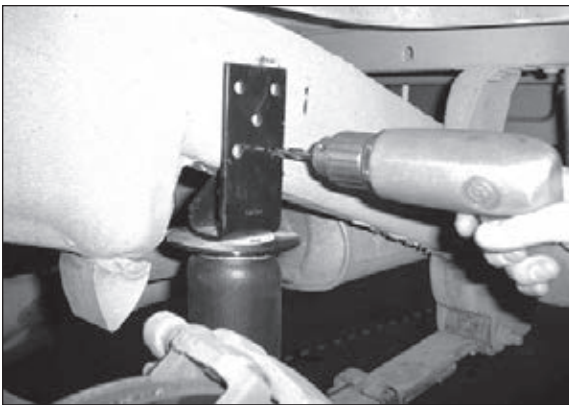

Figure 17

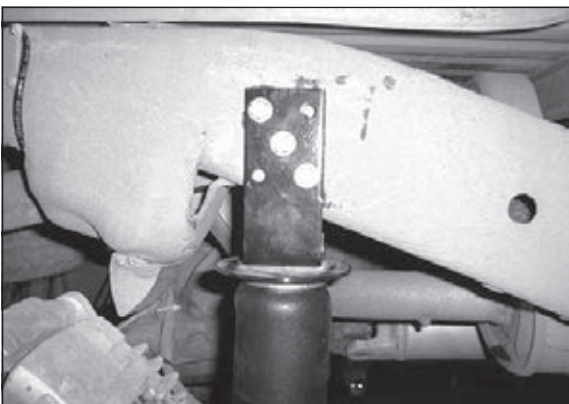

Figure 18

4. Be sure that the upper bracket is parallel and perpendicular to the lower bracket (Figures 11 and 12). Using the upper bracket as a template, center punch one hole (Figure 15). A welding clamp or C-clamp may assist in holding the upper bracket to the frame.

NOTE: It is necessary to use at least three of the five pre-drilled holes in the upper bracket for mounting. Any combination of the three is permissible.

5. **CAUTION:** Before drilling, be sure to check the back side of the frame rail for brake lines, gas lines, or electrical lines that may be in the way. It is necessary to move any interfering lines prior to drilling.

6. Drill one $\frac{5}{16}$ " hole and install one WHST (I). See Figure 16. Tighten to 15 ft-lbs.

IMPORTANT: Check again to make sure that the upper and lower brackets are parallel and perpendicular to each other (Figure 16).

7. Centerpunch and drill remaining two holes and install the WHST (I). Again, torque to 15 ft-lbs. Do not over tighten (Figure 17).

VI. Installing the Other Side

1. Install the minimum/maximum air pressure decal in a highly visible location.
2. Repeat entire installation procedure for remaining side.
3. Continue with section VII, Installing the Air Lines.

VII. Installing the Air Lines

1. Choose a convenient location for mounting the inflation valves. Popular locations for the inflation valve are:
 - a. The wheel well flanges.
 - b. License plate recess in bumper.
 - c. Under the gas cap access door.
 - d. Through license plate itself.

NOTE: What ever the chosen location is, make sure there is enough clearance around the inflation valves for an air chuck.

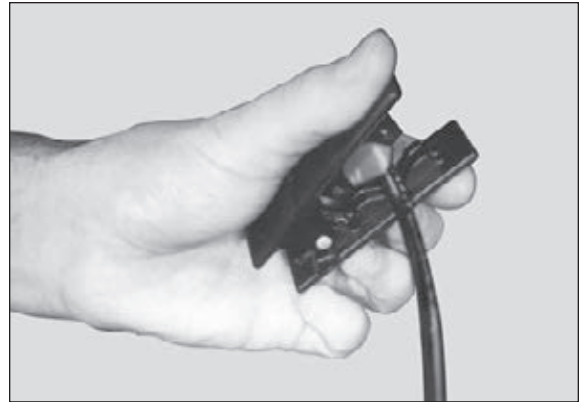

Figure 19

2. Drill a $\frac{5}{16}$ " hole to install the inflation valves.
3. Cut the air line assembly (AA) in two equal lengths (Figure 19).

CAUTION: When cutting or trimming the air line, use a hose cutter (Air Lift P/N 10530), a razor blade or a sharp knife. A clean, square cut will ensure against leaks. (Figure 20a). Do not use wire cutters or scissors to cut the air line. These tools may flatten or crimp the air line, causing it to leak around the O-ring seal inside the elbow fitting (Figure 20b).

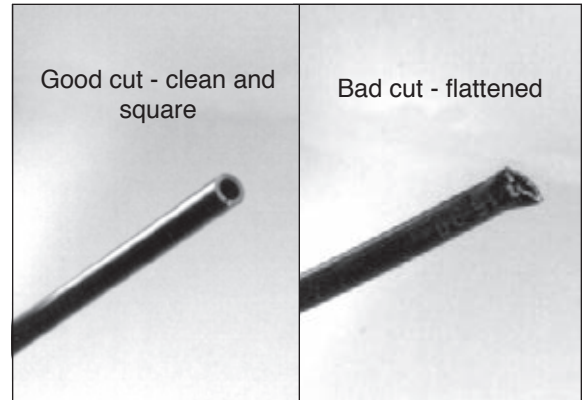

Figure 20a

Figure 20b

4. Place a $\frac{5}{16}$ " nut (GG) and a star washer (FF) on the air valve. Leave enough of the inflation valve in front of the nut to extend through the hole and have room for the rubber washer (EE), flat washer (DD), and $\frac{5}{16}$ " nut (GG) and cap (CC). There should be enough valve exposed after installation - approximately $\frac{1}{2}$ " - to easily apply a pressure gauge or an air chuck (Figure 21).
5. Push the inflation valve through the hole and use the rubber washer (EE), flat washer (DD), and another $\frac{5}{16}$ " nut (GG) to secure it in place. Tighten the nuts to secure the assembly in place (Figure 22).



Figure 21

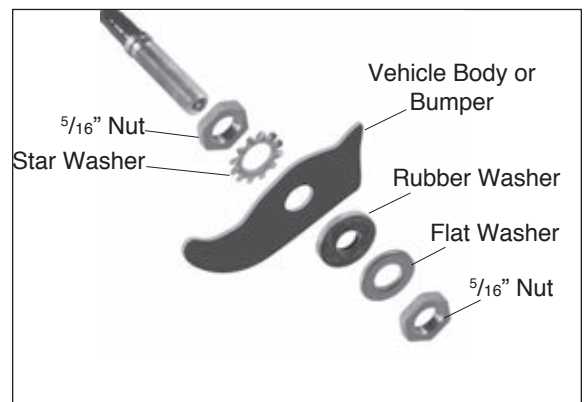

Figure 22

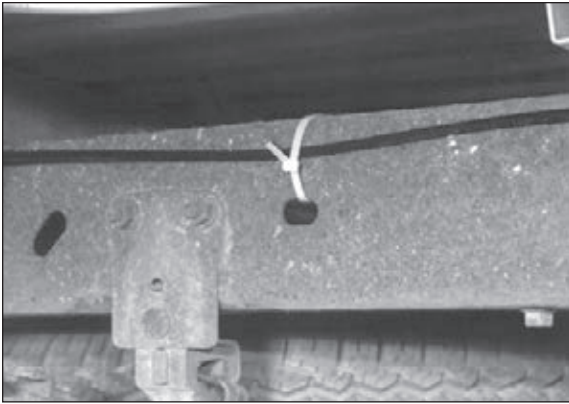

Figure 23

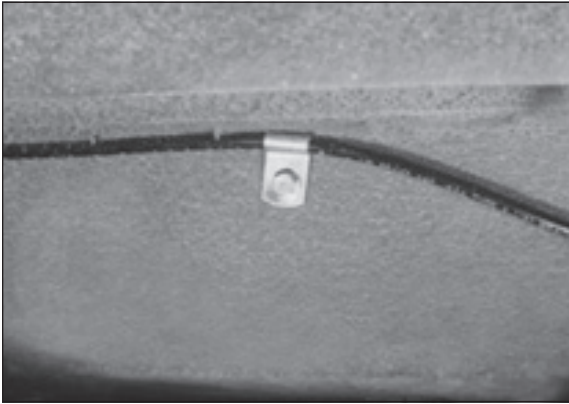

Figure 24

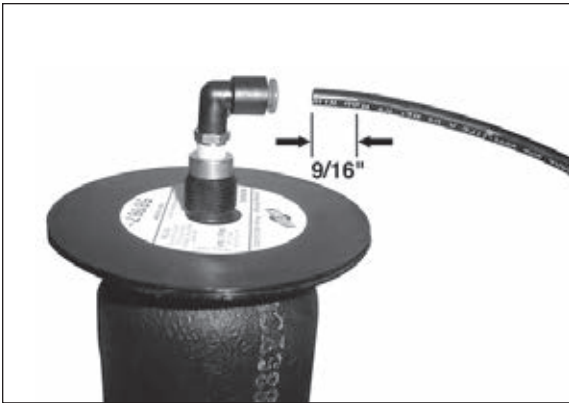

Figure 25

6. Route the air line along the frame to the air fitting on the air spring. Keep at least 6" of clearance between the air line and heat sources, such as the exhaust pipes, muffler, or catalytic converter. Avoid sharp bends and edges. Use the plastic tie straps (BB) to secure the air line to fixed, non-moving points along the chassis (Figure 23). Be sure that the tie straps are tight, but do not pinch the air line. Where there are no holes to secure the straps to, use the air line clip (HH) and self tapper (II) to secure the air line to the frame (Figure 24). Leave at least 2" of slack to allow for any movement that might pull on the air line.

7. Cut off air line leaving approximately 12" of extra air line. A clean square cut will ensure against leaks. Insert the air line into the air fitting. This is a push to connect fitting. Simply push the air line into the 90° swivel fitting until it bottoms out ($\frac{9}{16}$ " of air line should be in the fitting). See Figure 25.

VIII. Aligning the Air Springs

1. **IMPORTANT:** With the bottom of the air spring still loose, inflate the air spring to approximately 10 p.s.i. Use the slotted adjustment in the lower bracket to correctly align the air spring between the upper and lower bracket. This can be accomplished by tapping it inboard or outboard for proper alignment. There should be a symmetrical cushion of air around the base of the air spring when correctly positioned. Figure 26 represents a misaligned air spring. Figure 27 shows a properly aligned air spring.
2. When aligned, tighten the lower end by holding the air spring and turning the bolt with a $\frac{3}{4}$ " open end wrench (Figure 28). Snug (10 ft-lbs) will be sufficient and will also prevent stripping the threads. ***Do not attempt to hold the air spring with any type of tool.***
3. Figure 29 shows the completed installation.

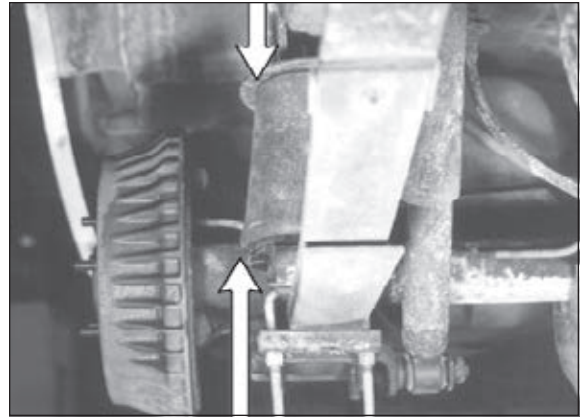

Figure 26

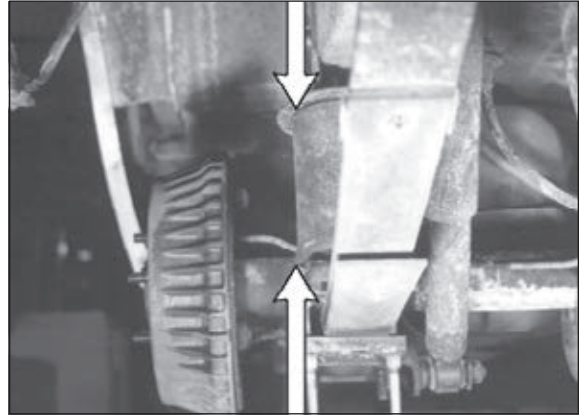

Figure 27



Figure 28

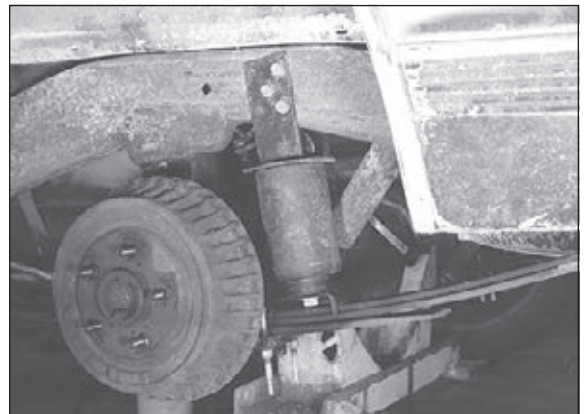

Figure 29

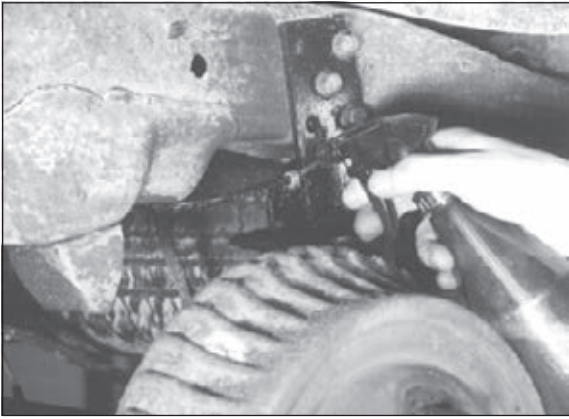

Figure 30

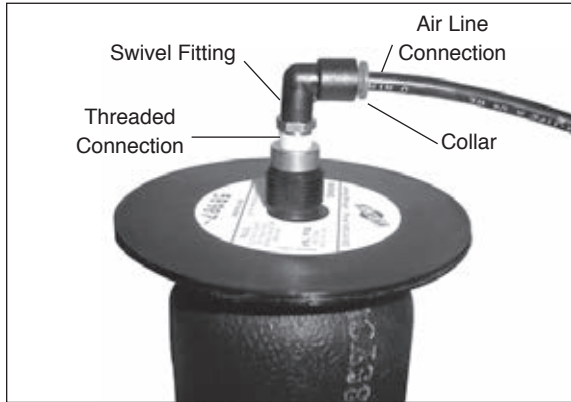

Figure 31

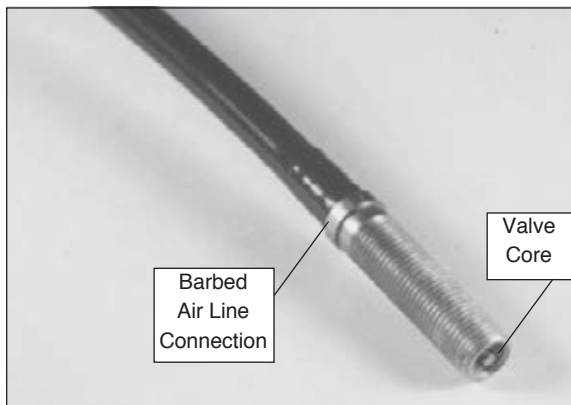

Figure 32

IX. Checking for Leaks

1. Inflate the air spring to 60 p.s.i.
2. Spray all connections and the inflation valves with a solution of $\frac{1}{5}$ liquid dish soap and $\frac{4}{5}$ water to check for leaks (Figure 30). You should be able to spot leaks easily by looking for bubbles in the soapy water.
3. After the test, deflate the springs to the minimum pressure required to restore the Normal Ride Height, but not less than 5 p.s.i.
4. **IMPORTANT:** Check the air pressure again after 24 hours. A 2 to 4 p.s.i. loss after initial installation is normal. Retest for leaks if the loss is more than 5 lbs.

X. Fixing Leaks

1. If there is a problem with the swivel fitting, then:
 - a. Check the air line connection by deflating the spring and removing the line by pulling the collar against the fitting and pulling firmly on the air line. Trim 1" off the end of the air line. Be sure the cut is clean and square. Reinsert the air line into the push-to-connect fitting. See Figure 31.
 - b. Check the threaded connection by tightening the swivel fitting another $\frac{1}{2}$ turn. If it still leaks, deflate the air spring, remove the fitting, and re-coat the threads with thread sealant. Reinstall by hand tightening as much as possible, then use a wrench for an additional two turns. See Figure 31.
2. If there is a problem with the inflation valve, then:
 - a. Check the valve core by tightening it with a valve core tool.
 - b. Check the air line connection (Figure 32) by removing the air line from the barbed type fitting. **CAUTION: Do not cut it off. As this will usually nick the barb and render the fitting useless.** Cut air line off a few inches in front of the fitting and use a pair of pliers or vise-grips to pull/twist the air line off the fitting.
3. If the preceding steps have not resolved the problem, call Air Lift Technical Service at 1-800-248-0892 for assistance.

XI. Troubleshooting Guide

Problems maintaining air pressure, without on-board compressor.

1. Leak test the air line connections and threaded connection of the elbow into the air spring (Figure 30). See Section X to repair.
2. Leak test the inflation valve for leaks at the air line connection or dirt or debris in the valve core (Figure 33). See Section X for repair.
3. Inspect air lines to be sure it is not pinched. Tie straps may be too tight. Loosen or replace strap. Replace leaking components (Figure 34).
4. Inspect air line for holes and cracks (Figure 35). Replace as needed.
5. A kink or fold in the air line (Figure 36). Reroute as needed.

You have now tested for all of the most probable leak conditions that can be easily fixed. At this point the problem is most likely a failed air spring - either a factory defect or an operating problem. Please call Air Lift at 1-800-248-0892 for assistance or a replacement air spring.



Figure 33

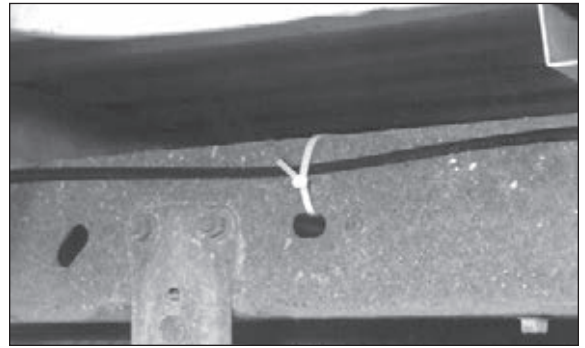

Figure 34

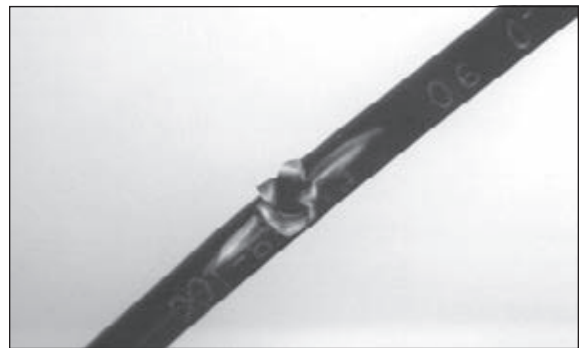

Figure 35



Figure 36

XII. Checklist

You can protect your warranty on this product and prevent unnecessary wear by ensuring the following checks have been made:

Section I - Installation (To be completed by the installer):

- 1. Clearance Test - Inflate the air springs to 60 p.s.i. and ensure there is at least 1/2 " clearance around each sleeve from anything that might rub against them. Be sure to check the tire, brake drum, frame, shock absorbers and brake cables.
- 2. Leak Test Before Road Test ñ Inflate the air springs to 60 p.s.i., check all connections for leaks with a soapy water solution. See pages 10 and 11 of the manual for tips on how to spot leaks. All leaks must be eliminated before the vehicle is road tested.
- 3. Heat Test - Be sure there is sufficient clearance from heat sources - at least 6" for air springs and air lines. If a heat shield was included in the kit - install it. If there is no heat shield, but one is required, call 1-800-248-0892.
- 4. Fastener Test - Recheck all bolts for proper torque.

Torque Guide:

WHST	15 ft-lbs
U-bolt Lock Nuts	16 ft-lbs
Lower Bolt for Air Spring	10 ft-lbs

- 5. Road Test - The vehicle should be road tested after the preceding tests. Inflate the springs to 25 p.s.i. (50 p.s.i. if vehicle is loaded). Drive the vehicle 10 miles and recheck for clearance, loose fasteners and/or air leaks.
- 6. Operating Instructions ñ If professionally installed, the installer should review the operating instructions on page 13 with the owner. Be sure to provide the owner with all of the paperwork that came with the kit.

Section II - Post Installation Checklist (To be completed by the owner):

- 1. Overnight Leakdown Test - Recheck air pressure after vehicle has been used for 24 hours. If pressure has dropped more than 5 p.s.i. then, you have a leak that must be fixed. Either fix the leak yourself (see pages 10 and 11) or return to the installer for service.
- 2. Air Pressure Requirements - I understand that the air pressure requirements of my air spring system are as follows:

Minimum _____ Maximum _____

I also understand that I must inflate the air springs until the Ride Height measurement that was recorded on page 2 has been restored. Regardless of load, the air pressure should always be adjusted so that the Ride Height is maintained at all times.

- 3. Thirty Day or 500 Mile Test. I understand that I must recheck the air spring system after 30 days or 500 miles, whichever comes first. If any part shows signs of rubbing or abrasion, the source should be identified and moved, if possible. If it is not possible to relocate the cause of the abrasion, the air spring may need to be remounted. If professionally installed, the installer should be consulted. Check all fasteners for tightness.

XIII. Maintenance and Operations

Minimum Air Pressure	Maximum Air Pressure
5 p.s.i.	100 p.s.i.
<i>Failure to maintain correct minimum pressure (or pressure proportional to load), bottoming out, over-extension, or rubbing against another component will void the warranty.</i>	

By following these steps, vehicle owners will obtain the longest life and best results from their air springs.

1. Check the air pressure weekly.
2. Always maintain Normal Ride Height. Never inflate beyond 100 p.s.i.
3. If you develop an air leak in the system, use a soapy water solution to check all air line connections and the inflation valve core before deflating and removing the air spring. (See page 9.)
4. When increasing load, always adjust the air pressure to maintain the Normal Ride Height. Increase or decrease pressure from the system as necessary to attain Normal Ride Height for optimal ride and handling. Remember that loads carried behind the axle (including tongue loads) require more leveling force (pressure) than those carried directly over the axle.
5. **IMPORTANT:** For your safety and to prevent possible damage to your vehicle, **do not exceed maximum Gross Vehicle Weight Rating (GVWR), as indicated by the vehicle manufacturer.** Although your air springs are rated at a maximum inflation pressure of 100 p.s.i. The air pressure actually needed is dependant on your load and GVWR, which may be less than 100 p.s.i. Check your vehicle owners manual and do not exceed the maximum load listed for your vehicle.
6. Always add air to springs in small quantities, checking the pressure frequently. Sleeves require less air volume than a tire and inflate quickly.
7. **Should it become necessary to raise the vehicle by the frame, make sure the system is at minimum pressure (5 p.s.i.) to reduce the tension on the suspension/brake components. Use of on-board leveling systems do not require deflation or disconnection.**

Thank you for purchasing Air Lift Products



Mailing Address:
AIR LIFT COMPANY
P.O. Box 80167
Lansing, MI 48908-0167

Street Address:
AIR LIFT COMPANY
2727 Snow Rd.
Lansing, MI 48917

Local Phone: (517) 322-2144
Fax: (517) 322-0240

For Technical Assistance call 1-800-248-0892

“The Choice of the Professional Installer”

Printed in the USA