



# LoadLIFTER 5000™

S E R I E S

Installation  
Guide



*2015-current Ford F-150*

**Kits 57268 | 88268**

**57284 | 88284 | 89284**

For maximum effectiveness and safety, please read these instructions completely before proceeding with installation.

## IDENTIFYING THE DIFFERENCES BETWEEN KITS

Should you need to contact Air Lift customer service, you will need to know which kit you are inquiring about: standard LoadLifter 5000, LoadLifter 5000 Ultimate or LoadLifter 5000 Ultimate Plus. The kits are easily identifiable by looking at the roll plates and air lines.

- Standard **LoadLifter 5000** – Zinc-plated steel roll plates and black nylon air lines.
- LoadLifter 5000 Ultimate** – Black powder-coated roll plates and black nylon air lines.
- LoadLifter 5000 Ultimate Plus** – Stainless steel roll plates, braided stainless steel air lines, stainless steel air spring mounting hardware.

Air Lift offers two Ultimate Plus upgrade kits:

**52300** - Braided stainless steel air line and fittings.

**52301** - Stainless steel roll plates, air spring mounting hardware, braided stainless steel air lines and fittings.



LoadLifter 5000  
silver zinc-plated steel  
roll plate



LoadLifter 5000 Ultimate  
black powder-coated  
roll plate



LoadLifter 5000 Ultimate Plus  
stainless steel  
roll plate



LoadLifter 5000  
nylon air line



LoadLifter 5000 Ultimate  
nylon air line



LoadLifter 5000 Ultimate PLUS  
braided stainless steel air line

# TABLE OF CONTENTS

<b>Installation Diagrams</b> .....	<b>2</b>
<b>Hardware and Tools Lists</b> .....	<b>3</b>
<b>Introduction</b> .....	<b>4</b>
Important Safety Notice .....	4
Notation Explanation .....	4
<b>Installing the LoadLifter 5000 Series System</b> .....	<b>5</b>
Getting Started .....	5
Assembling the Air Spring Assemblies .....	10
Installing the Air Spring Assemblies .....	11
Finishing the Installation .....	13
<b>Installing the Air Lines</b> .....	<b>14</b>
Installing Nylon Air Lines .....	14
Installing Braided Stainless Steel Air Lines .....	15
Installing the Heat Shield .....	15
<b>Before Operating</b> .....	<b>16</b>
Checking for Leaks .....	16
Fixing Leaks .....	16
Installation Checklist .....	17
Post-Installation Checklist .....	17
<b>Product Use, Maintenance and Servicing</b> .....	<b>18</b>
Minimum and Maximum Pressure .....	18
Maintenance Guidelines .....	18
Tuning the Air Pressure .....	19
Guidelines for Adding Air .....	19
<b>Troubleshooting Guide</b> .....	<b>20</b>
Frequently Asked Questions .....	20
<b>Limited Warranty and Return Policy</b> .....	<b>21</b>
<b>Replacement Information</b> .....	<b>21</b>
<b>Contact Information</b> .....	<b>21</b>

# Installation Diagrams

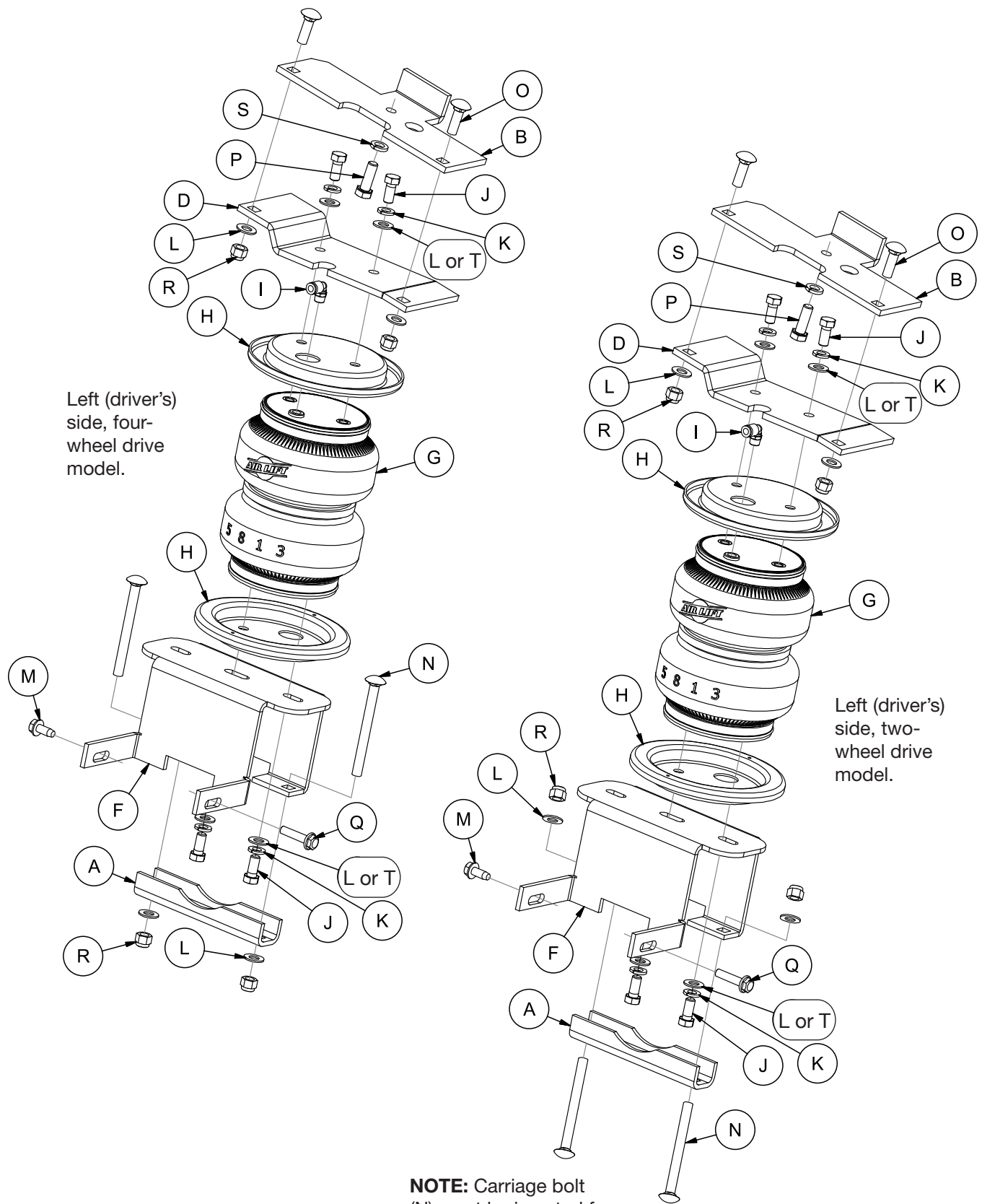

Left (driver's) side, four-wheel drive model.

Left (driver's) side, two-wheel drive model.

**NOTE:** Carriage bolt (N) must be inverted for Two-wheel drive models.

*fig. 1*

# Hardware and Tools Lists

## Common Parts Included in All 3 Kits

Item	Part#	Description .....	Qty
A	01531	Clamp bar .....	2
B	07181	Left frame bracket.....	1
C*	07274	Right frame bracket .....	1
D	07179	Left air spring upper bracket.....	1
E*	07280	Right air spring upper bracket .....	1
F1	03023	Lower bracket (2WD) (57268, 88268).....	2
F2	03024	Lower bracket (4WD) (57284, 88284, 89284).....	2
M	17102	5/16"-18 x 3/4" Self-tapping screw .....	2
N	17168	3/8"-16 x 5" Carriage bolt.....	4
O	17361	3/8"-16 x 1.25" Carriage bolt.....	4
P	17409	M10-1.50 x 30 Hex-cap screw .....	2
Q	17469	M8-1.25 x 25 Flange bolt.....	3
R	18435	3/8"-16 Nylon lock nut.....	8
S	18540	M10 Lock washer.....	2
EE*	21234	Rubber washer.....	2

\* not pictured in the Installation Diagrams

## TOOLS LIST

Description.....	Qty
Standard and metric open-end or box wrenches .....	SET
Ratchet .....	1
Standard and Metric, regular and deep-well sockets.....	SET
5/16" drill bit (very sharp) .....	1
Heavy-duty drill .....	1
Torque wrench.....	1
Standard and metric hex-key wrenches .....	1
Hose cutter, razor blade, or sharp knife .....	1
Hoist or floor jacks .....	1
Safety stands.....	2
Safety glasses .....	1
Air compressor or compressed air source .....	1
Spray bottle with dish soap/water solution.....	1

The photos in this manual show the LoadLifter 5000 Ultimate kit.

## Unique Parts in Each Kit

			KIT 57268
			KIT 57284
Item	Part#	Description .....	Qty
G	58439	Air spring.....	2
H	11951	Roll plate (silver zinc plated) .....	4
I	21839	Push-to-connect (PTC) fitting .....	2
J	17203	3/8"-24 x 7/8" Hex-head bolt.....	8
K	18427	3/8" Lock washer.....	8
L	18444	3/8" Flat washer .....	16
AA*	20086	Air line .....	1
BB*	10466	Zip tie .....	6
CC*	21230	Valve cap.....	2
DD*	18501	M8 Flat washer.....	2
GG*	21233	5/16" Hex nut.....	4
FF*	18411	Star washer.....	2

			KIT 88268
			KIT 88284
Item	Part#	Description .....	Qty
G	58494	Air spring with jounce bumper .....	2
H	11967	Roll plate (black powder coated) .....	4
I	21839	Push-to-connect (PTC) fitting .....	2
J	17203	3/8"-24 x 7/8" Hex-head bolt.....	8
K	18427	3/8" Lock washer.....	8
L	18444	3/8" Flat washer .....	16
AA*	20086	Air line .....	1
BB*	10466	Zip tie .....	6
CC*	21230	Valve cap.....	2
DD*	18501	M8 Flat washer.....	2
GG*	21233	5/16" Hex nut.....	4
FF*	18411	Star washer .....	2

			KIT 89284
Item	Part#	Description .....	Qty
G	58494	Air spring with jounce bumper .....	2
H	11880	Roll plate (stainless steel).....	4
I	21815	AN-type fitting.....	2
J	17284	3/8"-24 x 7/8" Stainless steel hex-head bolt.....	8
K	18504	3/8" Stainless steel lock washer .....	8
L	18444	3/8" Flat washer .....	8
T	18507	3/8" Stainless steel flat washer.....	8
AA*	20987	Stainless steel braided air line .....	2
BB*	10466	Zip tie .....	12
DD*	18572	M8 Stainless steel flat washer .....	2
FF*	18623	Stainless steel star washer .....	2
HH*	21709	Fill valve with cap & nut .....	2
II*	21813	PTC to AN adapter fitting.....	2
JJ*	20084	Air line assembly.....	1



Missing or damaged parts? Call Air Lift customer service at (800) 248-0892 for a replacement part.

# Introduction

The purpose of this publication is to assist with the installation, maintenance and troubleshooting of the standard LoadLifter 5000, LoadLifter 5000 Ultimate or LoadLifter 5000 Ultimate Plus air spring kits. All LoadLifter 5000 Series kits utilize sturdy, reinforced, commercial-grade single or double, depending on the kit, convolute bellows. LoadLifter 5000 Ultimate kits add an internal jounce bumper and black powder-coated roll plates. LoadLifter 5000 Ultimate Plus kits also have an internal jounce bumper, but add stainless steel roll plates, air lines and air spring mounting hardware.

The air springs are manufactured like a tire with layers of rubber and cords that control growth. LoadLifter 5000 series kits are recommended for most 3/4- and 1-ton pickups and SUVs with leaf springs and provide up to 5,000 pounds of load-leveling support with air adjustability from 5-100 PSI.

It is important to read and understand the entire installation guide before beginning installation or performing any maintenance, service or repair.

Air Lift Company reserves the right to make changes and improvements to its products and publications at any time. For the latest version of this manual, contact Air Lift Company at **(800) 248-0892** or visit [airliftcompany.com](http://airliftcompany.com).

## IMPORTANT SAFETY NOTICE

The installation of this kit does not alter the gross vehicle weight rating (GVWR) or payload of the vehicle. Check the vehicle's owner's manual and do not exceed the maximum load listed for this vehicle.

**Gross vehicle weight rating:** The maximum allowable weight of the fully loaded vehicle (including passengers and cargo). This number — along with other weight limits, as well as tire, rim size and inflation pressure data — is shown on the vehicle's Safety Compliance Certification Label.

**Payload:** The combined, maximum allowable weight of cargo and passengers that the truck is designed to carry. Payload is GVWR minus the base curb weight.

## NOTATION EXPLANATION

Hazard notations appear in various locations in this publication. Information which is highlighted by one of these notations must be observed to help minimize risk of personal injury or possible improper installation which may render the vehicle unsafe. Notes are used to help emphasize areas of procedural importance and provide helpful suggestions. The following definitions explain the use of these notations as they appear throughout this guide.



INDICATES IMMEDIATE HAZARDS WHICH WILL RESULT IN SEVERE PERSONAL INJURY OR DEATH.



INDICATES HAZARDS OR UNSAFE PRACTICES WHICH COULD RESULT IN SEVERE PERSONAL INJURY OR DEATH.



INDICATES HAZARDS OR UNSAFE PRACTICES WHICH COULD RESULT IN DAMAGE TO THE MACHINE OR MINOR PERSONAL INJURY.

---

## NOTE

*Indicates a procedure, practice or hint which is important to highlight.*

---

# Installing the LoadLifter 5000 Series System

## GETTING STARTED

1. Lift the vehicle and support the frame with jack stands. Leave enough room to drop the axle down low enough to install the air spring assemblies into position between the axle and the frame (Fig. 2).

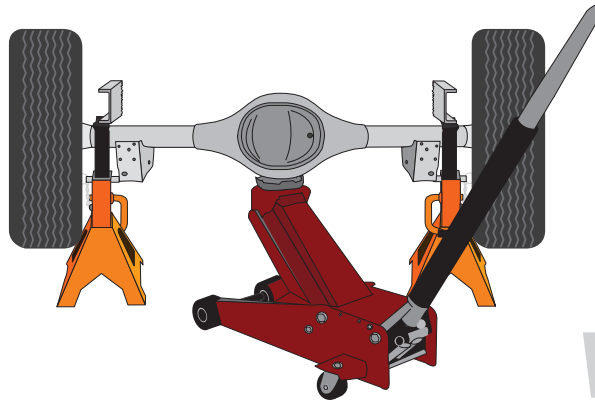

*fig. 2*

2. Remove the jounce bumpers and cups (Fig. 3). Figure 4 shows the left (driver's) side frame with the jounce bumper removed.



*fig. 3*



*fig. 4*

3. Install the left (driver's) side frame bracket (B) onto the frame, ensuring that the flange is on the inside of the frame. The large hole under the bracket will be behind the axle as shown (Fig. 5). Attach with the M10 hex cap screw (P) and lock washer (S), making sure that the bracket is parallel to the ridge that is under the frame rail. Torque to 35 lb.-ft. (47Nm). Repeat for the right (passenger's) side.

The large hole in the upper bracket will be behind the axle.

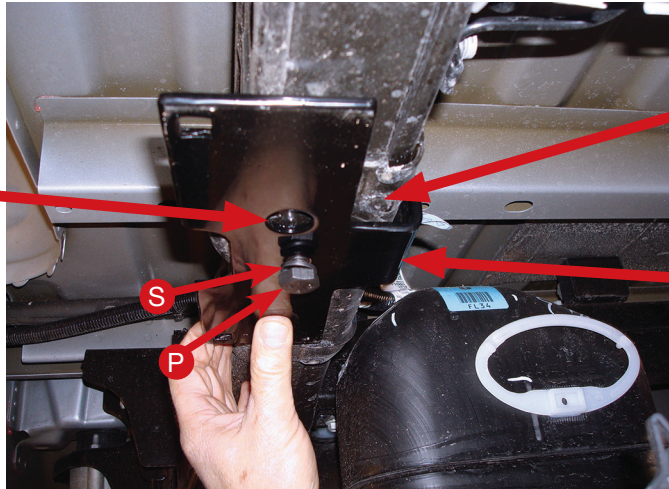

The frame has a ridge; the bracket must be parallel to this ridge.

The flange on the bracket must be inboard of the frame.

*fig. 5*

4. In order to install the lower brackets, remove the stock M8 hardware holding the brake/ABS and emergency brake line brackets to the spring perches (Figs. 6 & 7) and pull the brackets slightly away from the spring perch.

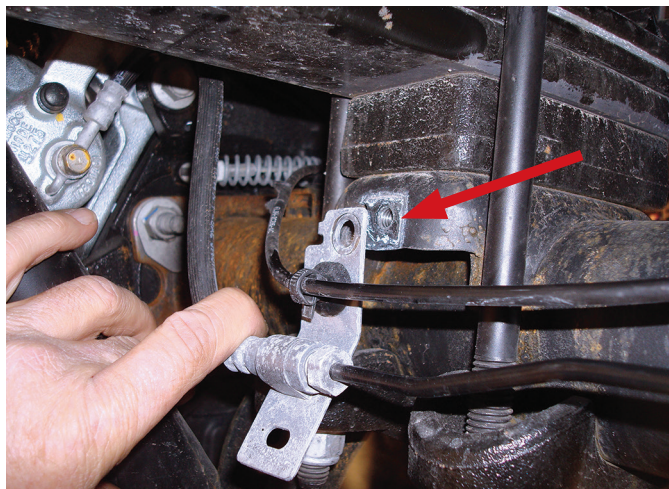

*fig. 6*

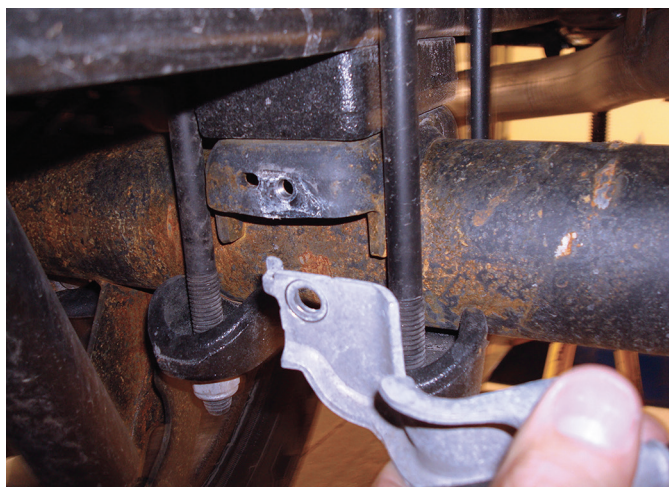

Emergency brake cable forward of passenger's side

*fig. 7*



- On the front of the driver's side spring perch there is a hole and a slot (Fig. 8). In order to mount the lower bracket, it will be necessary to tap the hole using the 5/16" self-tapping screw (M) by starting the bolt making sure it is perpendicular to the perch. Use a ratchet and socket to drive the bolt in, creating the threads in the spring perch (Fig. 9). Remove the bolt for later use.

**NOTE**

*If this truck does not have an emergency brake cable bracket and mounting bolt on the right (passenger's) side as noted (has an open hole as noted on driver's side) Follow step 5 for this side by self-tapping the hole.*



It will be necessary to tap the round hole in the forward driver's side spring perch. If there is no emergency brake cable bracket and mounting bolt as specified in Fig. 7 on the passenger's side, repeat and tap the round hole as instructed.

*fig. 8*

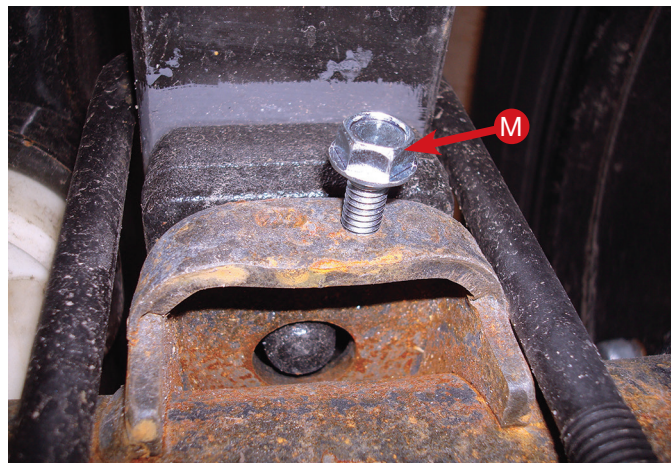

*fig. 9*

- Set the lower bracket (F1 or F2) on the axle, making sure the tabs wrap around the spring perch (Fig. 10). Repeat for the other side.

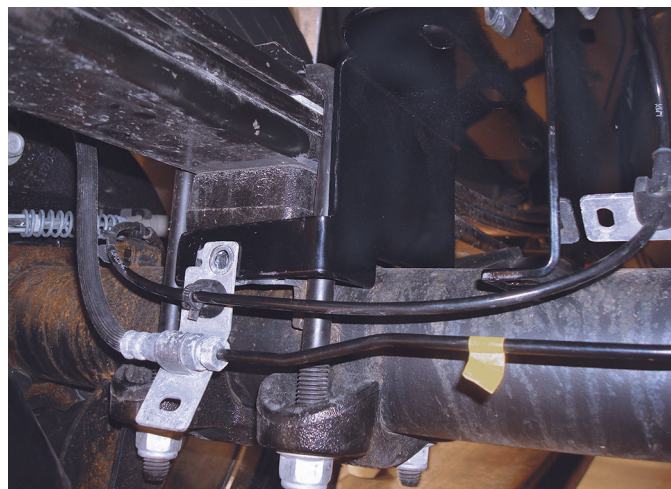

**Note:**  
Four-wheel drive installation shown.

*fig. 10*

- Index the brake line/ABS bracket alignment tabs through the lower bracket on the back of the spring perch, and reattach using the M8 flange bolt (Q) provided (Fig. 11). Also, attach the emergency brake line bracket on the front of the passenger's side spring perch in the same manner. Finish by installing the 5/16" bolt previously used to tap the forward spring perch hole and **LEAVE ALL HARDWARE LOOSE AT THIS TIME.**

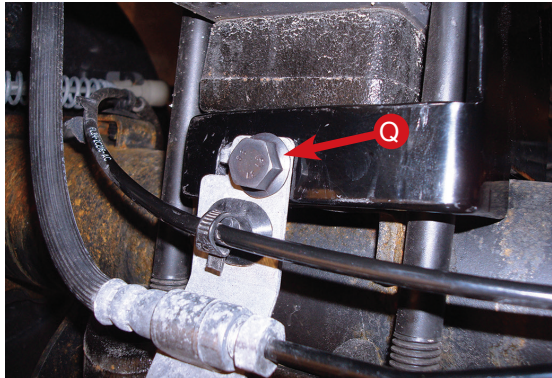
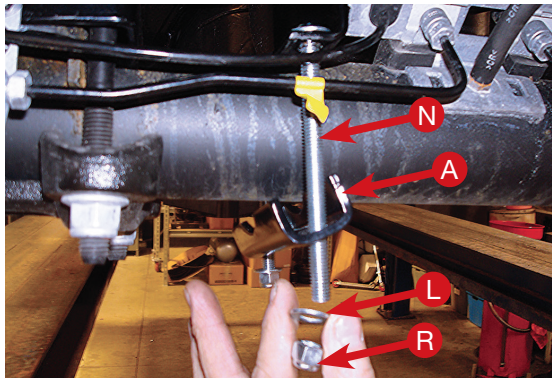

*fig. 11*

- For the **4WD models**, insert the long 3/8" carriage bolts (N) through the lower bracket (Fig. 12).

**NOTE**

*Due to the tight clearance for the U-bolt to be positioned into place, it may be necessary to "rotate" or "screw" the carriage bolt into the square hole in the bracket.*

- Slide the clamp bar (A) over the carriage bolts and cap with a 3/8" flat washer (L) and nylon lock nut (R) (Fig. 12). Snug the nylon lock nuts evenly until the clamp bar just makes contact with the axle. Do not torque at this time.

**Note:**

Four-wheel drive installation shown.

*fig. 12*

- For the **2WD models**, it will be necessary to invert the carriage bolt (install it upside down) (Fig. 13).

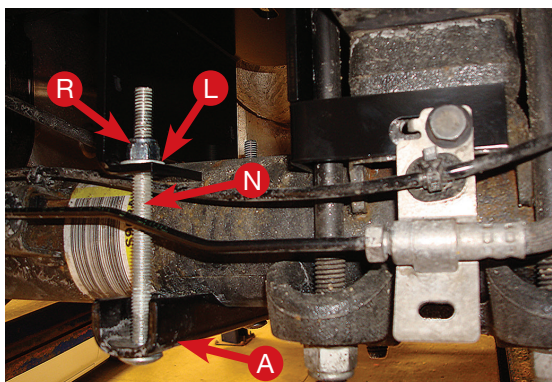

**Note:**

Two-wheel drive installation shown.

*fig. 13*

11. Once the clamp bar is snug to the axle, torque all the spring perch hardware to 20 lb.-ft. (27Nm) Then torque the axle clamp hardware to 15 lb.-ft. (20Nm). Figures 14-17 (four-wheel drive) and 18-21 (two-wheel drive) show the lower bracket once it has been mounted to the axle.

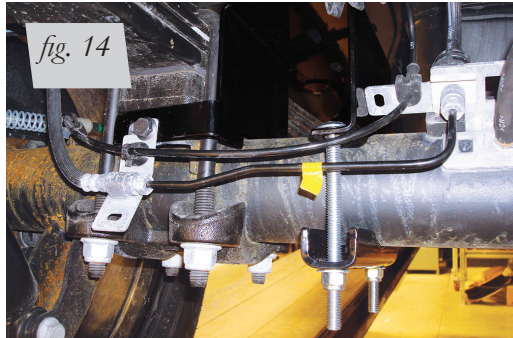
**Four-wheel drive models with lower bracket installed:**



Driver's side rear view

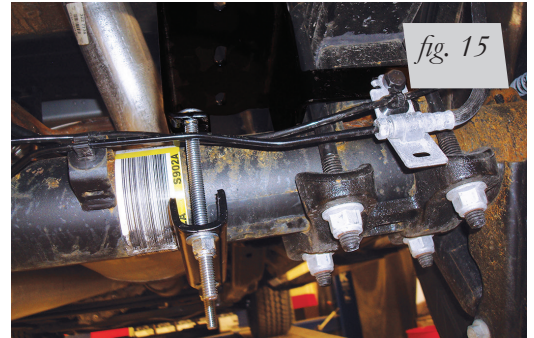

Passenger's side rear view

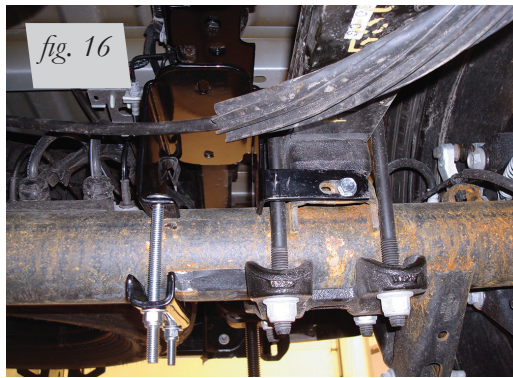

Driver's side front view

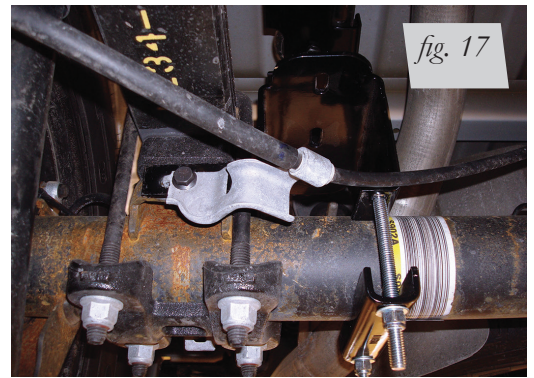

Passenger's side front view

**Two-wheel drive models with lower bracket installed:**

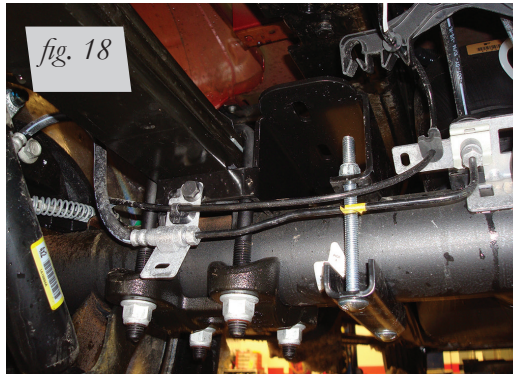

Driver's side rear view

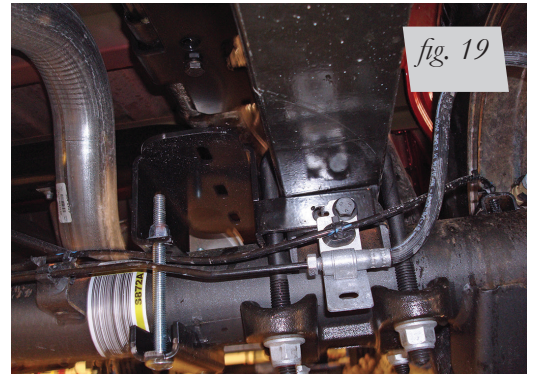

Passenger's side rear view

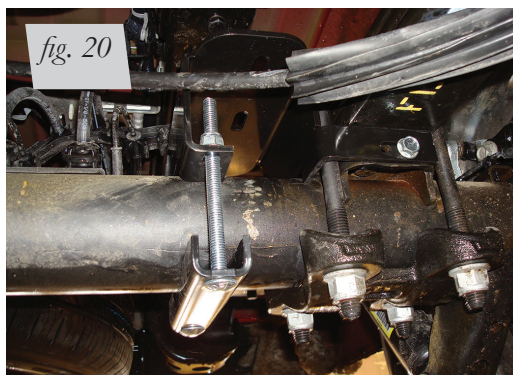

Driver's side front view

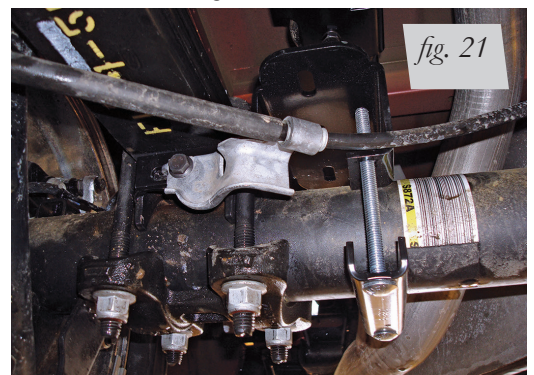

Passenger's side front view

## ASSEMBLING THE AIR SPRING ASSEMBLIES

1. Set a roll plate (H) over the air spring (G).

**NOTE**

*The radiused (rounded) edge of the roll plate (H) will be toward the air spring, so that the air spring is seated inside both roll plates.*

2. Install the swivel fitting (I) into the top of the air spring finger-tight plus one-and-a-half turns (Fig. 22). Repeat for both air springs.

*fig. 22*

3. Set the upper left air spring bracket (D) onto the air spring so that the slot is on the fitting side (it will only bolt on one way) and attach with two 3/8" screws (J), two lock washers (K) and two flat washers (L or T) (Fig. 23). Torque the mounting hardware to no more than 20 lb.-ft. (27Nm). Repeat for the opposite side. Figure 24 shows the left and right assemblies.

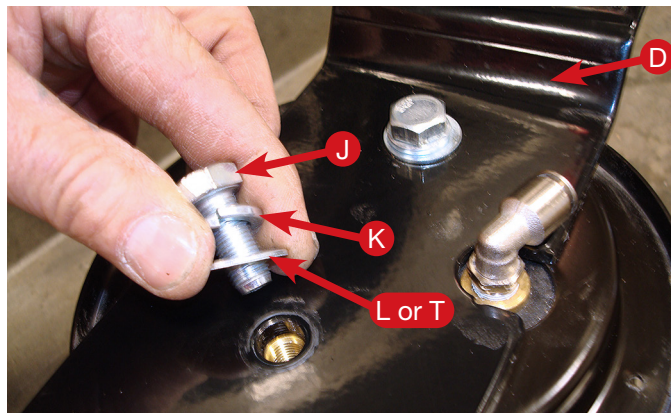
*fig. 23*

*fig. 24*

## INSTALLING THE AIR SPRING ASSEMBLIES

1. With the axle dropped low enough to put the assemblies into position, set the left and right assemblies on the previously installed lower brackets, making sure that the fittings are on the outside of the frame as shown. Lift and attach the air spring upper bracket to the frame bracket using two 3/8" carriage bolts (O), two flat washers (L) and two nylon lock nuts (R) (Figs. 25 & 26). Torque hardware to 20 lb.-ft. (27Nm). Repeat for the opposite side.

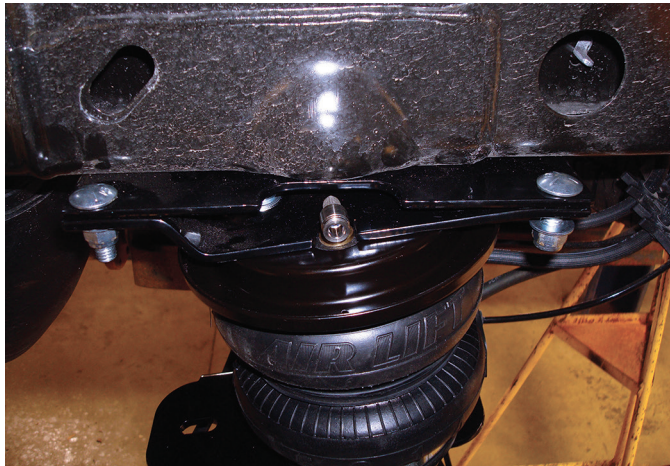

Driver's side (left) assembly shown.

**NOTE:** Fitting goes on the outside of the frame.

*fig. 25*

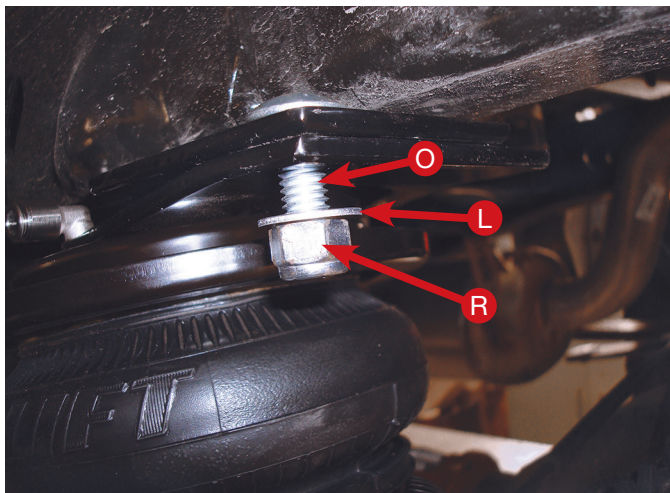

*fig. 26*

2. Set a roll plate in between the air spring and the lower bracket. Align the holes in the lower bracket and roll plate to the threaded inserts in the air spring (Fig. 27).



Slide the roll plate between the lower bracket and air spring while aligning the holes in all three.

*fig. 27*

3. Raise the suspension back up just enough so that the air spring comes in contact with the roll plate and the lower bracket. Align the holes again and attach the lower air spring to the lower bracket using two 3/8" hex-head bolts (J), two lock washers (K) and two flat washers (L or T) (Fig. 28). Repeat for the opposite side.
4. Raise the axle all the way up and adjust the air spring by pushing it forward in the slot. Make sure it is aligned so that it is perpendicular to the upper and lower bracket. Torque the lower mounting bolts to no more than 20 lb.-ft. (27Nm).

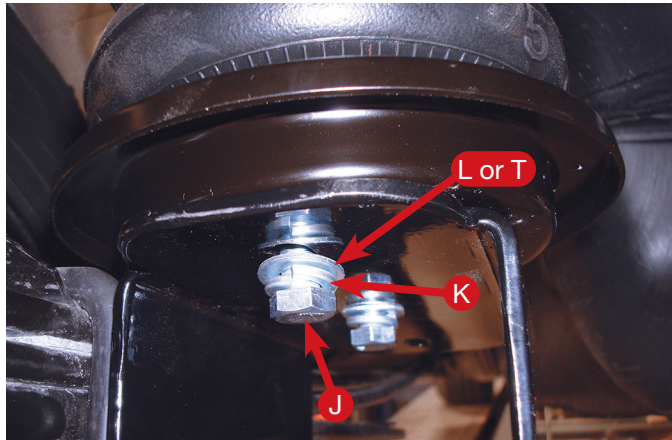

Align the holes in the lower bracket and roll plate to the threaded insert in the air spring and attach with (L or T), (K) and (J).

*fig. 28*

5. Remove the jack stands.
6. Figures 29, 30 & 31 show the finished installation of both left and right assemblies (four-wheel models shown).

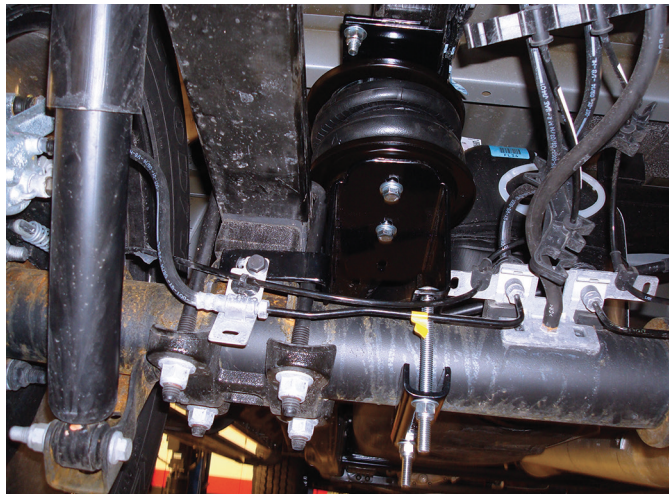

Back view of left-side mounted assembly

*fig. 29*

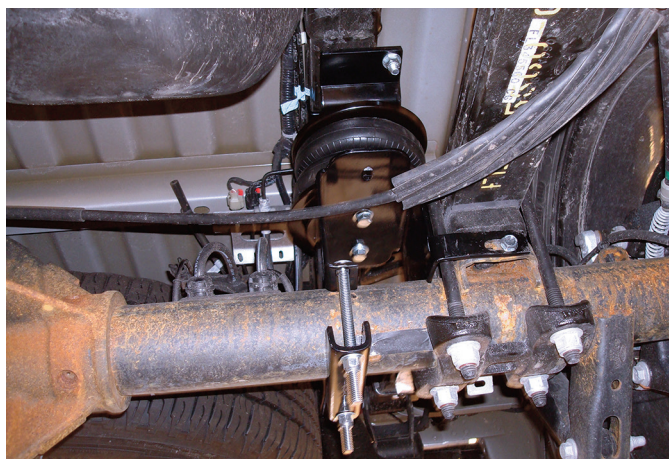

Front view of left-side mounted assembly

*fig. 30*

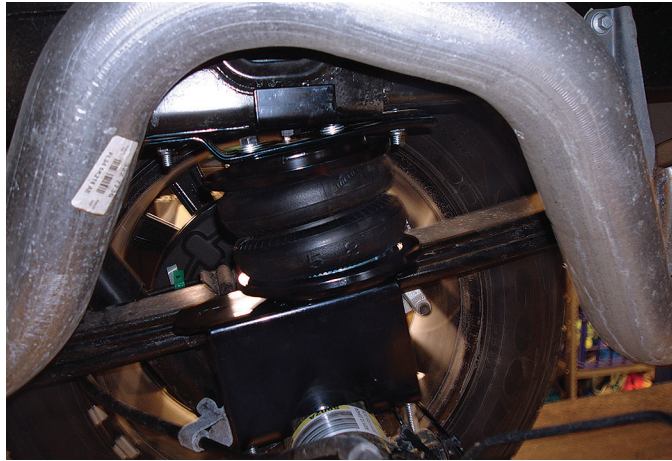

Inside view of right-side mounted assembly

*fig. 31*

### FINISHING THE INSTALLATION

For 2WD models it will be necessary to trim the brake/ABS line holder that is closest to the axle so that it does not chafe on the driver's side air spring.

1. Trim the outboard open slot on the plastic line holder off using a hack saw or side cutters (Fig. 32). Finished photo shown in Figure 33.

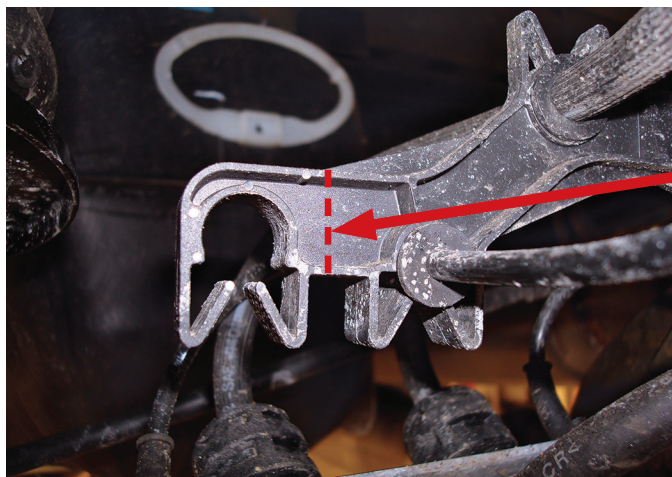

Trim brake/ABS line holder off here.

*fig. 32*



*fig. 33*

# Installing the Air Lines

Air lines are routed from the air springs to Schrader valves. LoadLifter 5000 Series air lines come in two styles: nylon and braided stainless steel. Begin by choosing locations for the Schrader valves and drill a 5/16" hole, if necessary (Fig. 34).

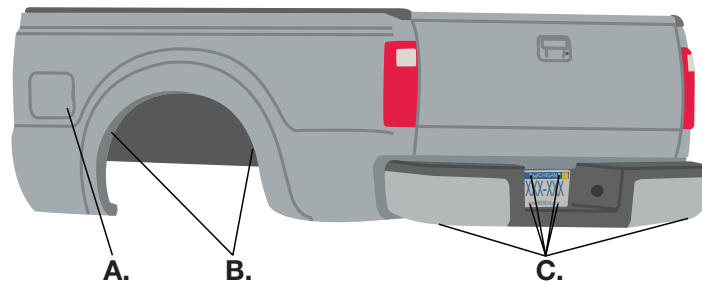

*fig. 34*

\* For LoadLifter Ultimate Plus kits, the recommended location for the Schrader valves is the rear bumper area or license plate.

**CAUTION**

KEEP AT LEAST 6" OF CLEARANCE BETWEEN ALL AIR LINES AND THE EXHAUST SYSTEM. AVOID SHARP BENDS AND EDGES.

## INSTALLING NYLON AIR LINES

1. Cut the air line in half. Make clean, square cuts with a razor blade or hose cutter (Fig. 35). Do not use scissors or wire cutters.

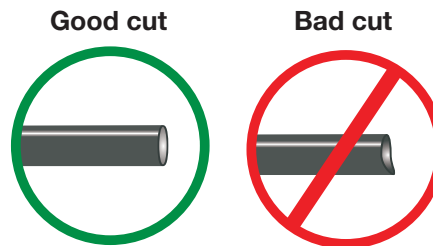

*fig. 35*

2. Use zip ties to secure the air line to fixed points along the chassis. Do not pinch or kink the air line. The minimum bend radius for the air line is 1". Leave at least 2" of slack in the air line to allow for any movement that might pull on the air line.
3. Install the Schrader valve in the chosen location (Fig. 36).

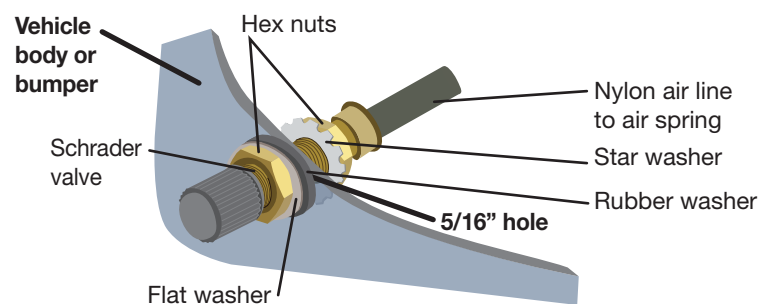

*fig. 36*



## INSTALLING BRAIDED STAINLESS STEEL AIR LINES

**CAUTION**

KEEP THE AIR LINE AWAY FROM THE FUEL LINE, BRAKE LINES AND ELECTRICAL WIRES.

1. Use zip ties to secure the air line to fixed points along the chassis every 6" to 8". Leave at least 2" of slack to allow for any movement that might pull on the air line.
2. Tighten the air line hex nut finger tight, then use 2 wrenches to turn 1 additional flat (1/6 of one full turn). **Do not overtighten** (Figs. 37 or 38). The easiest way to tighten the fitting is off the vehicle. Install the Schrader valve in the chosen location.
3. Coil and secure any excess air line in an area where it will not be susceptible to damage. The braided stainless steel air line cannot be trimmed.

### Air Line Setup Without Compressor System

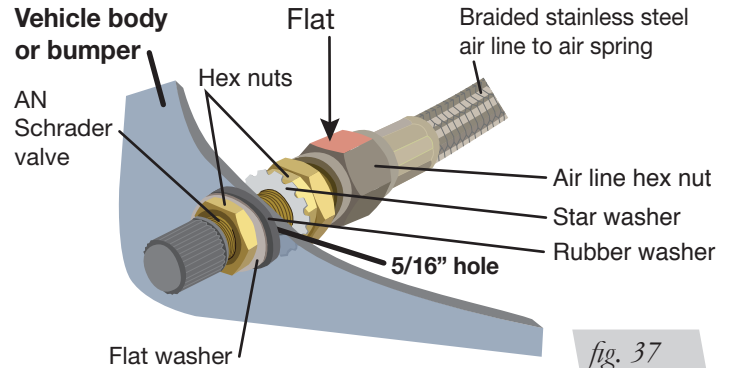

fig. 37

### Air Line Setup for Compressor Integration

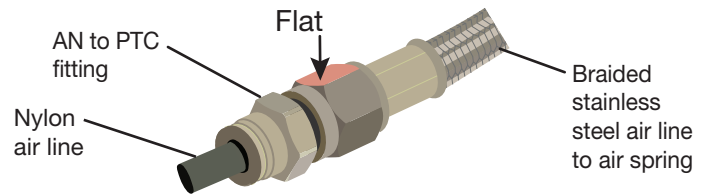

fig. 38

# Before Operating

## CHECKING FOR LEAKS

1. Inflate the air spring to 30 PSI.
2. Spray all connections and the inflation valves with a solution of 1/5 liquid dish soap and 4/5 water. Spot leaks easily by looking for bubbles in the soapy water.
3. After the test, deflate the springs to the minimum pressure required to restore the system to normal ride height. Do not deflate to lower than 5 PSI.
4. Check the air pressure again after 24 hours. A 2-4 PSI loss after initial installation is normal. Retest for leaks if the loss is more than 5 PSI.

## FIXING LEAKS

1. If there is a problem with the swivel fitting:
  - a. Check the air line connection by deflating the spring and removing the line by pulling the collar against the fitting and pulling firmly on the air line. Trim 1" off the end of the air line. Be sure the cut is clean and square (see Fig. 35). Reinsert the air line into the push-to-connect fitting.
  - b. Check the threaded connection by tightening the swivel fitting another half turn. If it still leaks, deflate the air spring, remove the fitting, and re-coat the threads with thread sealant. Reinstall by hand tightening as much as possible and then use a wrench for an additional two turns.
2. If there is a problem with the inflation valve:
  - a. Check the valve core by tightening it with a valve core tool.
  - b. Check the air line by removing the air line from the barbed type fitting. Cut the air line off a few inches in front of the fitting and use a pair of pliers or vice grips to pull/twist the air line off of the fitting.

**CAUTION**

DO NOT CUT OFF THE AIR LINE COMPLETELY AS THIS WILL USUALLY NICK THE BARB AND RENDER THE FITTING USELESS.

3. If the preceding steps have not resolved the problem, call Air Lift customer service at **(800) 248-0892**.

## INSTALLATION CHECKLIST

- Clearance test** — Inflate the air springs to 75-90 PSI and make sure there is at least 1/2" clearance from anything that might rub against each sleeve. Be sure to check the tire, brakes, frame, shock absorbers and brake cables.
- Leak test before road test** — Inflate the air springs to 75-90 PSI and check all connections for leaks. All leaks must be eliminated before the vehicle is road tested.
- Heat test** — Be sure there is sufficient clearance from heat sources, at least 6" for air springs and air lines. If a heat shield was included in the kit, install it. If there is no heat shield, but one is required, call Air Lift customer service at **(800) 248-0892**.
- Fastener test** — Recheck all bolts for proper torque.
- Road test** — The vehicle should be road tested after the preceding tests. Inflate the springs to recommended driving pressures. Drive the vehicle 10 miles and recheck for clearance, loose fasteners and air leaks.
- Operating instructions** — If professionally installed, the installer should review the operating instructions with the owner. Be sure to provide the owner with all of the paperwork that came with the kit.

## POST-INSTALLATION CHECKLIST

- Overnight leak down test** — Recheck air pressure after the vehicle has been used for 24 hours. If the pressure has dropped more than 5 PSI, then there is a leak that must be fixed. Either fix the leak yourself or return to the installer for service.
- Air pressure requirements** — It is important to understand the air pressure requirements of the air spring system. Regardless of load, the air pressure should always be adjusted to maintain adequate ride height at all times while driving.
- Thirty-day or 500-mile test** — Recheck the air spring system after 30 days or 500 miles, whichever comes first. If any part shows signs of rubbing or abrasion, the source should be identified and moved, if possible. If it is not possible to relocate the cause of the abrasion, the air spring may need to be remounted. If professionally installed, the installer should be consulted. Check all fasteners for tightness.

# Product Use, Maintenance and Servicing

Minimum Recommended Pressure	Maximum Air Pressure
5 PSI	100 PSI

## MAINTENANCE GUIDELINES

### NOTE

*By following the steps below, vehicle owners will obtain the longest life and best results from their air springs.*

1. Check air pressure weekly.
2. Always maintain normal ride height. Never inflate beyond 100 PSI.
3. If the system develops an air leak, use a soapy water solution (1/5 liquid dish soap and 4/5 water) to check all air line connections and the inflation valve core before deflating and removing the air spring.

### CAUTION

FOR SAFETY AND TO PREVENT POSSIBLE DAMAGE TO THE VEHICLE, DO NOT EXCEED MAXIMUM GROSS VEHICLE WEIGHT RATING (GVWR), AS INDICATED BY THE VEHICLE MANUFACTURER. ALTHOUGH THE AIR SPRINGS ARE RATED AT A MAXIMUM INFLATION PRESSURE OF 100 PSI, THE AIR PRESSURE ACTUALLY NEEDED IS DEPENDENT ON LOAD AND GVWR.

4. Loaded vehicles require at least 25 PSI. A “loaded vehicle” refers to a vehicle with a heavy bed load, a trailer or both. Never exceed GVWR, regardless of air spring, air pressure or other load assist. The springs in this kit will support approximately 40 pounds of load (combined on both springs) for each 1 PSI of pressure. The required air pressure will vary depending on the state of the original suspension. Operating the vehicle below the minimum air spring pressure will void the Air Lift warranty.
5. When increasing load, always adjust air pressure to maintain normal ride height. Increase or decrease pressure from the system as necessary to attain normal ride height for optimal ride and handling. Remember that loads carried behind the axle (including tongue loads) require more leveling force (pressure) than those carried directly over the axle.
6. Always add air to springs in small quantities, checking the pressure frequently.
7. Should it become necessary to raise the vehicle by the frame, make sure the system is at minimum pressure (5 PSI) to reduce the tension on the suspension/ brake components. Use of on-board leveling systems do not require deflation or disconnection.
8. Periodically check the air spring system fasteners for tightness. Also, check the air springs for any signs of rubbing. Realign if necessary.
9. On occasion, give the air springs a hard spray with a garden hose to remove mud, sand, gravel or other debris.

## TUNING THE AIR PRESSURE

Pressure determination comes down to three things — level vehicle, ride comfort and stability.

### 1. Level vehicle

If the vehicle's headlights are shining into the trees or the vehicle is leaning to one side, then it is not level (Fig. 39). Raise the air pressure to correct either of these problems and level the vehicle.

### 2. Ride comfort

If the vehicle has a rough or harsh ride it may be due to either too much pressure or not enough (Fig. 40). Try different pressures to determine the best ride comfort.

### 3. Stability

Stability translates into safety and should be the priority, meaning the driver may need to sacrifice a perfectly level and comfortable ride. Stability issues include roll control, bounce, dive during braking and sponginess (Fig. 41). Tuning out these problems usually requires an increase in pressure.

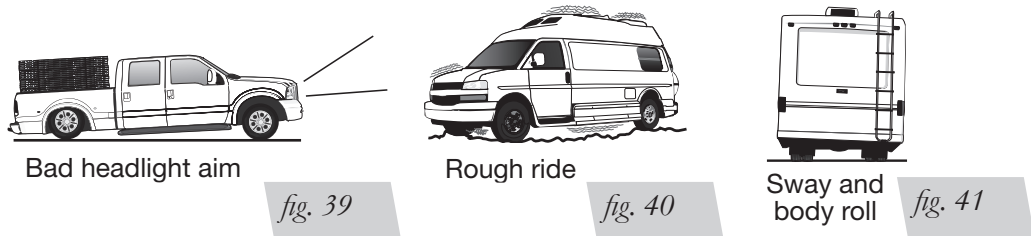

## GUIDELINES FOR ADDING AIR

1. Start with the vehicle level or slightly above.
2. When in doubt, always add air.
3. If the front of the vehicle dives while braking, increase the pressure in the front air bags, if equipped.
4. If it is ever suspected that the air bags have bottomed out, increase the pressure (Fig. 42).
5. Adjust the pressure up and down to find the best ride.
6. If the vehicle rocks and rolls, adjust the air pressure to reduce movement.
7. It may be necessary to maintain different pressures on each side of the vehicle. Loads such as water, fuel, and appliances will cause the vehicle to be heavier on one side (Fig. 43). As much as a 50 PSI difference is not uncommon.

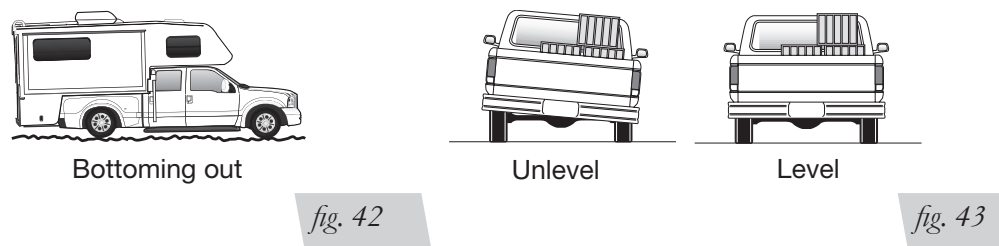

# Troubleshooting Guide

PROBLEM	CAUSE	SOLUTION
System won't maintain pressure overnight.	Improperly installed air line, air line has holes or cracks.	Leak test the air line connections, the threaded connection into the air spring, and all fittings in the control system.
Air spring or air line leak.	Fitting seal or air line is compromised.	Check to make sure air lines are seated in connectors. Inspect fittings with soapy water. Trim hose or re-seal fitting. Ensure lines are cut straight.
Corner won't raise or air leak develops.	Look for a kink or fold in the air line.	Replace any air line that has been kinked.

## FREQUENTLY ASKED QUESTIONS

**Q. Will installing air springs increase the weight ratings of a vehicle?**

No. Adding air springs will not change the weight ratings (GAWR, GCWR and/or GVWR) of a vehicle. Exceeding the GVWR is dangerous and voids the Air Lift warranty.

**Q. Is it necessary to keep air in the air springs at all times and how much pressure will they need?**

For LoadLifter 5000 standard, Ultimate and Ultimate Plus, the recommended minimum air pressure is 5 PSI, but it can safely be run at zero air pressure unladen (no load).

**Q. Is it necessary to add a compressor system to the air springs?**

No. Air pressure can be adjusted with any type of compressor as long as it can produce sufficient pressure to service the springs. Even a bicycle tire pump can be used, but it's a lot of work.

**Q. How long should air springs last?**

If the air springs are properly installed and maintained they can last indefinitely.

**Q. Will raising the vehicle on a hoist for service work damage the air springs?**

No. The vehicle can be lifted on a hoist for short-term service work such as tire rotation or oil changes. However, if the vehicle will be on the hoist for a prolonged period of time, support the axle with jack stands in order to take the tension off of the air springs.



# Limited Warranty and Return Policy

Air Lift Company provides a limited lifetime warranty to the original purchaser of its Load Support products, that the products will be free from defects in workmanship and materials when used on cars and trucks as specified by Air Lift Company and under normal operating conditions, subject to the requirements and exclusions set forth in the full Limited Warranty and Return Policy that is available online at [www.airliftcompany.com/warranty](http://www.airliftcompany.com/warranty).

For additional warranty information contact Air Lift Company customer service.

# Replacement Part Information

If replacement parts are needed, contact the local dealer or call Air Lift customer service at **(800) 248-0892**. Most parts are immediately available and can be shipped the same day.

**Contact Air Lift Company customer service at (800) 248-0892 first if:**

- Parts are missing from the kit.
- Need technical assistance on installation or operation.
- Broken or defective parts in the kit.
- Wrong parts in the kit.
- Have a warranty claim or question.

**Contact the retailer where the kit was purchased:**

- If it is necessary to return or exchange the kit for any reason.
- If there is a problem with shipping if shipped from the retailer.
- If there is a problem with the price.

# Contact Information

<b>Mailing address</b>	P.O. Box 80167 Lansing, MI 48908-0167
<b>Shipping address for returns</b>	2727 Snow Road Lansing, MI 48917
<b>Phone</b>	Toll free: (800) 248-0892 International: (517) 322-2144
<b>Email</b>	<a href="mailto:service@airliftcompany.com">service@airliftcompany.com</a>
<b>Web address</b>	<a href="http://www.airliftcompany.com">www.airliftcompany.com</a>



***Thank you for purchasing Air Lift Products— the Authorized Installer's choice!***

## **Need Help?**

**Contact Air Lift Company Customer Service at (800) 248-0892  
or email [service@airliftcompany.com](mailto:service@airliftcompany.com).**

**For calls outside the U.S. or Canada, dial (517) 322-2144.**