

LoadLIFTER™ 5000

by AIR LIFT®

Kit 57229

Nissan Titan XD

2WD and 4WD

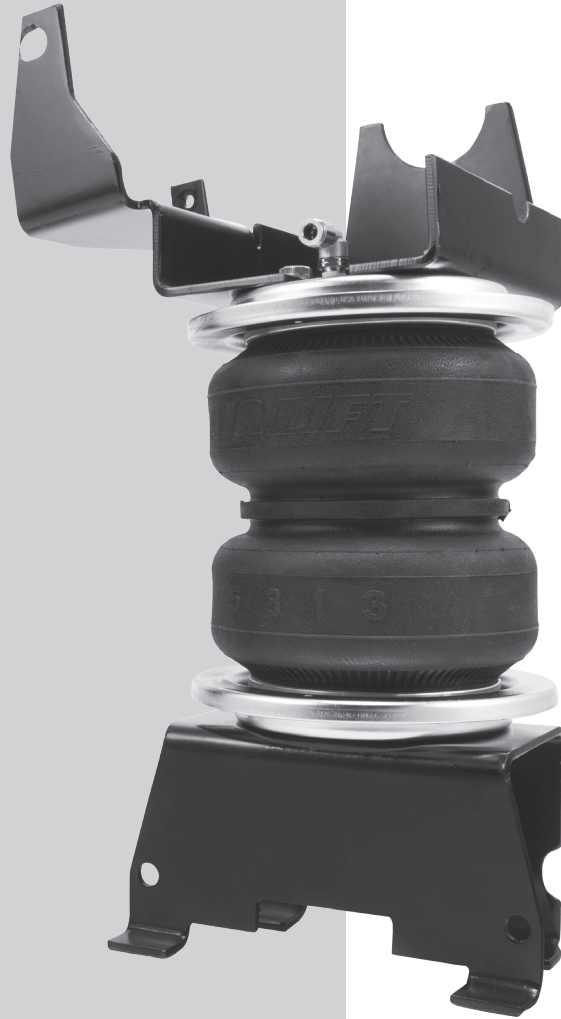

INSTALLATION GUIDE

For maximum effectiveness and safety, please read these instructions completely before proceeding with installation.

Failure to read these instructions can result in an incorrect installation.



TABLE OF CONTENTS



A. Installation Diagrams	2
B. Hardware List and Tools List	3
Hardware List	3
Tools List	3
C. Introduction	4
Important Safety Notice	4
Notation Explanation	4
D. Installing the LoadLifter Ultimate 5000 System	5
Getting Started	5
Assembling the Air Spring	8
Installing the Assemblies	10
E. Installing the Air Lines	14
Tips for Installing Air Lines	15
F. Finished Installation Photos	16
G. Before Operating	17
Checking for Leaks	17
Fixing Leaks	17
Installation Checklist	18
Post-Installation Checklist	18
H. Product Use, Maintenance and Servicing	19
Minimum and Maximum Pressure	19
Maintenance Guidelines	19
Tuning the Air Pressure	20
Guidelines for Adding Air	20
I. Troubleshooting Guide	21
Frequently Asked Questions	21
Limited Warranty and Returns Policy	24
Replacement Part Information	25
Contact Information	25



A. Installation Diagram

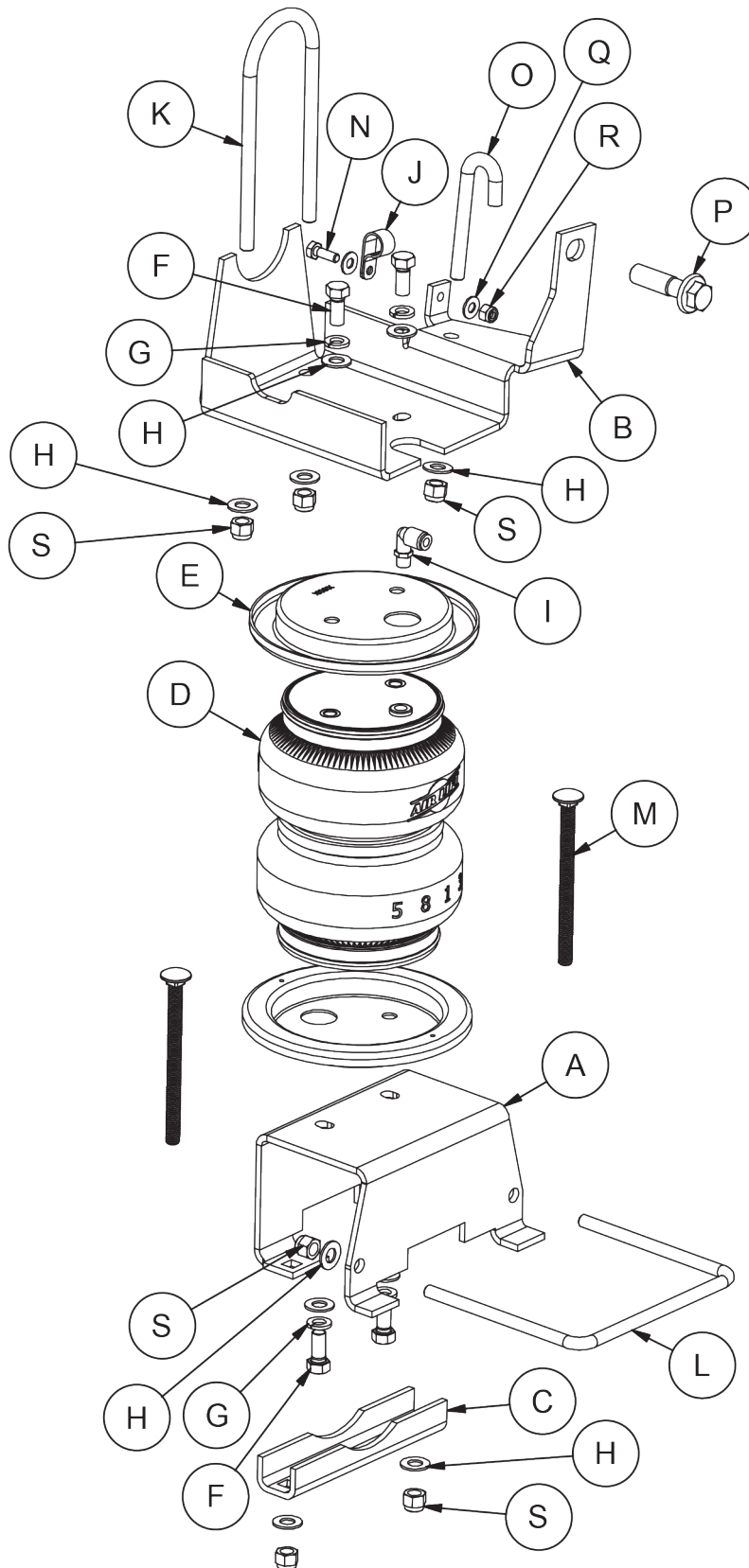

fig. A.1

B. Hardware and Tools Lists

HARDWARE LIST

Item	Part #	Description	QTY
A	03912	Lower bracket	2
B1	07802	L.H. upper bracket	1
B2	07903	R.H. upper bracket	1
C	01531	Axle clamp bar	2
D	58437	Air spring	2
E	11951	Roll plate*	4
F	17203	3/8"-24 x 7/8" hex cap screw	8
G	18427	3/8" lock washer	8
H	18444	3/8" flat washer	26
I	21837	90° swivel elbow fitting	2
J	10976	P-clamp	2
K	11520	U-bolt, round	2
L	11717	U-Bolt, square	2
M	17166	3/8"-16 x 4" carriage bolt	4
N	17261	1/4"-20 x 3/4" Hex head screw	2
O	17309	3/8"-16 x 3.75" J-bolt	2
P	17508	M14-1.5 x 40 Hex flange bolt	2
Q	18419	#12 Flat washer	4
R	18425	1/4"-20 Nylon lock nut	2
S	18435	3/8"-16 Nylon Lock nut	18
T	20086	Hose assembly	1
U	10466	Tie straps	6
V	18501	5/16" Flat washer	2
W	18411	Star washer	2
X	21230	Valve cap	2
Y	21233	5/16" Hex nut	4
Z	21234	Rubber washer	2

TOOLS LIST

Description	Qty
Metric and STD open-box end wrenches	set
Ratchet with metric and STD sockets.....	set
Drill and 5/16" drill bit.....	1
Torque wrench.....	1
Hose cutter, razor blade or sharp knife	1
Hoist or floor jack	1
Safety stands.....	2
Safety glasses	1
Air compressor or compressed air source	1
Spray bottle with dish soap/water solution.....	1
Blue (medium strength) threadlocking compound	1

* **NOTE:** The pictures in this manual show the LoadLifter 5000 Ultimate kit installation. Visually, the only difference is Ultimate kits have black roll plates and standard LoadLifter 5000 kits have silver roll plates.



LoadLifter 5000 Ultimate black roll plate



LoadLifter 5000 silver roll plate



Missing or damaged parts? Call Air Lift customer service at **(800) 248-0892** for a replacement part.

C. Introduction

The purpose of this publication is to assist with the installation, maintenance and troubleshooting of the LoadLifter 5000 air spring kit. LoadLifter 5000 utilizes sturdy, reinforced, commercial grade single or double, depending on the kit, convolute bellows. The bellows are manufactured like a tire with layers of rubber and cords that control growth. LoadLifter 5000 Ultimate kits are recommended for most 3/4- and 1-ton pickups and SUVs with leaf springs and provide up to 5,000 pounds of load leveling support with air adjustability from 5-100 PSI. The kits are also used in motor home rear kits and some motor home fronts where leaf springs are used.

It is important to read and understand the entire installation guide before beginning installation or performing any maintenance, service or repair. The information here includes a hardware list, tool list, step-by-step installation information, maintenance guidelines and operating tips.

Air Lift Company reserves the right to make changes and improvements to its products and publications at any time. For the latest version of this manual, contact Air Lift Company at **(800) 248-0892** or visit airliftcompany.com.

IMPORTANT SAFETY NOTICE

The installation of this kit does not alter the gross vehicle weight rating (GVWR) or payload of the vehicle. Check your vehicle's owner's manual and do not exceed the maximum load listed for your vehicle.

Gross vehicle weight rating: The maximum allowable weight of the fully loaded vehicle (including passengers and cargo). This number — along with other weight limits, as well as tire, rim size and inflation pressure data — is shown on the vehicle's Safety Compliance Certification Label.

Payload: The combined, maximum allowable weight of cargo and passengers that the truck is designed to carry. Payload is GVWR minus the base curb weight.

NOTATION EXPLANATION

Hazard notations appear in various locations in this publication. Information which is highlighted by one of these notations must be observed to help minimize risk of personal injury or possible improper installation which may render the vehicle unsafe. Notes are used to help emphasize areas of procedural importance and provide helpful suggestions. The following definitions explain the use of these notations as they appear throughout this guide.



DANGER

INDICATES IMMEDIATE HAZARDS WHICH WILL RESULT IN SEVERE PERSONAL INJURY OR DEATH.



WARNING

INDICATES HAZARDS OR UNSAFE PRACTICES WHICH COULD RESULT IN SEVERE PERSONAL INJURY OR DEATH.



CAUTION

INDICATES HAZARDS OR UNSAFE PRACTICES WHICH COULD RESULT IN DAMAGE TO THE MACHINE OR MINOR PERSONAL INJURY.

NOTE

Indicates a procedure, practice or hint which is important to highlight.

C. Installing the LoadLifter 5000 System

GETTING STARTED

1. Raise the vehicle and support it using jack stands or equivalent, so the axle can be safely dropped away from the frame. This is necessary in order for the air spring assembly to be put into position between the axle and frame (Fig. D.1). The vehicle is shown on a drive-on hoist with the axle supported.

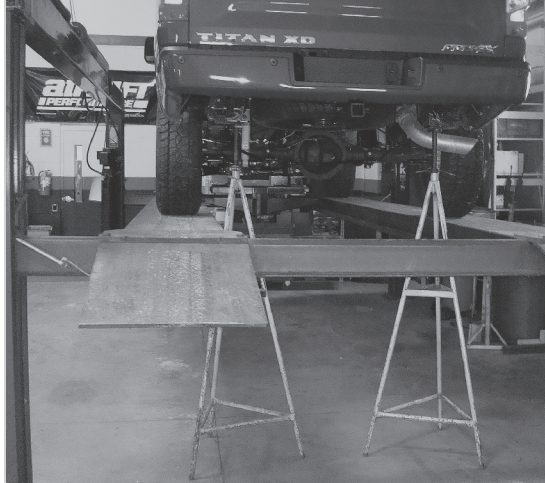

fig. D.1

2. It will be necessary to pull the plastic harness fasteners away from the frame on the wiring harness behind the axle on both the passenger's and driver's side so that the harness is loose from the frame (Fig. D.2).

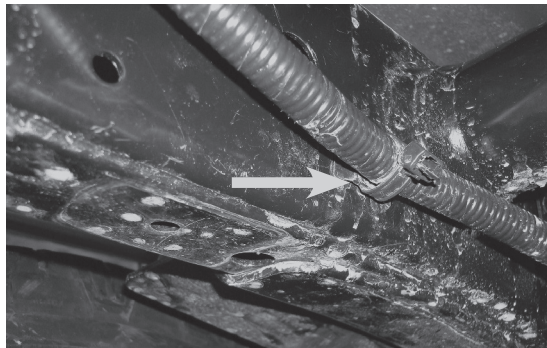

fig. D.2

3. Unbolt and pull aside the frame vent tube bracket and the vent tube itself so that it is away from the frame. This will be reattached later in the installation (Fig. D.3).



fig. D.3

4. Remove the rear 5th-wheel hitch frame bolts and discard bolt. (Fig. D.4).

*fig. D.4*

5. Remove the ABS line from the bracket on the passenger's side axle (Fig. D.5).

*fig. D.5*

6. On the driver's side line, loosen the left bolt that holds the rear brake line to the rear axle bracket. Rotate the brake line counter clockwise as far as it will go. Tighten the brake line bolt so the line stays in this position (Fig. D.6). This is done to gain clearance for the lower bracket.

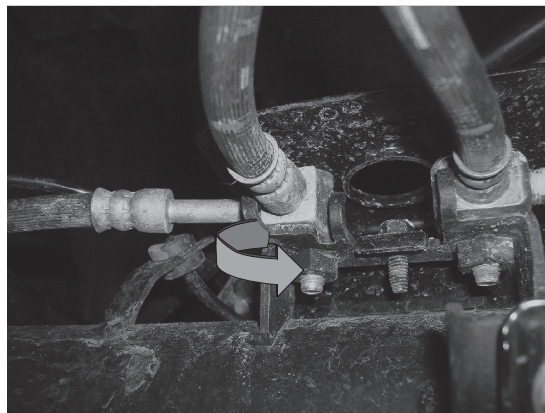

Loosen the bolt holding the brake line to the axle bracket and rotate the brake line counterclockwise as far as it can go. Tighten the brake line bolt so the line stays in this position.

fig. D.6

7. In the large hole on the inside of the frame rail, just behind the round crossmember, insert the J-bolt (O) into the large hole on both the driver's and passenger's sides (Figs. D.7 & D.8).

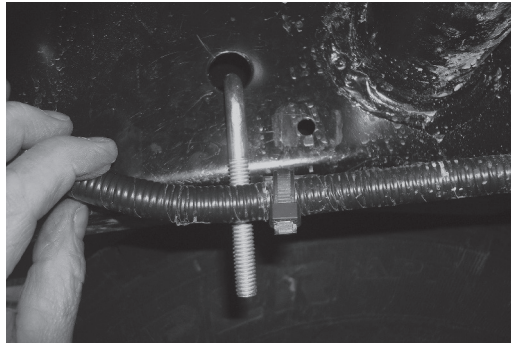
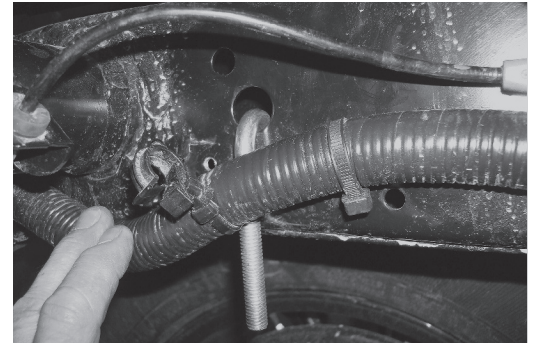

fig. D.7 Driver's side



Passenger's side *fig. D.8*

8. Install the lower bracket/spring perch U-bolt (L) by first inserting it around the spring perch, forward of the axle. Then, rotate it around the back side of the perch, making sure that the U-bolt fits in between the ABS line/bracket and the spring (Figs. D.9, D.10 & D.11).

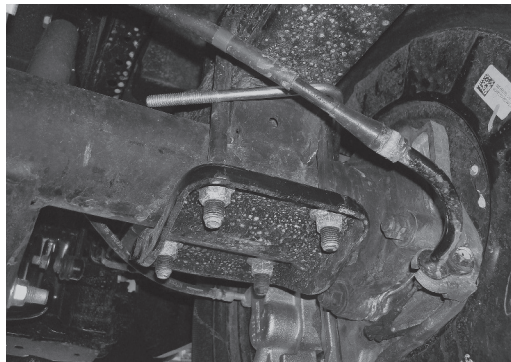
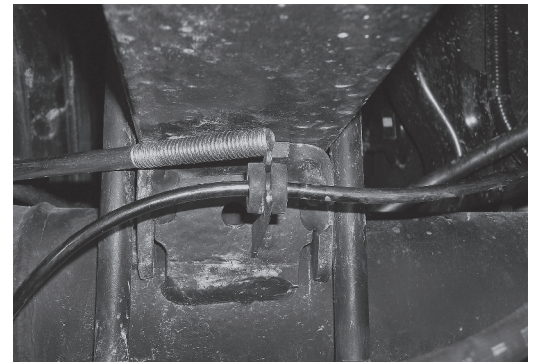

fig. D.9 Start U-bolt from the front side of the axle and rotate backward around the spring perch.



Make sure U-bolt goes between the ABS line/bracket and the leaf spring. *fig. D.10*



fig. D.11 U-bolt in position for use on the lower bracket.

- Set the round U-bolt (K) into position over the round crossmember located above the axle (Fig. D.12) on both the driver's and passenger's side.

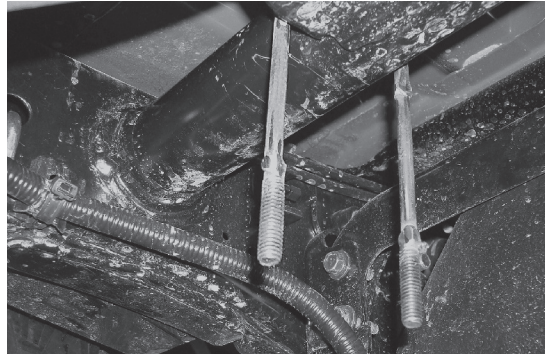

Set the round U-bolts around the cross member over the axle, as shown, on both driver's and passenger's sides. Be careful not to pinch any wiring that may be in the area on the driver's side.

fig. D.12

NOTE

Make sure not to pinch the lines that are on the driver's side, above the crossmember.

ASSEMBLING THE AIR SPRING

- Set a roll plate (E) on top of the air spring (D). The radiused, or rounded, edge of the roll plate should be toward the air spring so that it is seated inside the roll plate (Fig. D.13). Install the 90° swivel fitting (I) into the top of the air spring, making sure that it is finger tight plus one and a half turns.



fig. D.13

- Set both upper brackets (B1 & B2) onto the top of the air springs and attach with two 3/8"-16 x 7/8" hex cap screws (F), 3/8" lock washers (G) and 3/8" flat washers (H) (Fig. D.14). Leave loose at this time.

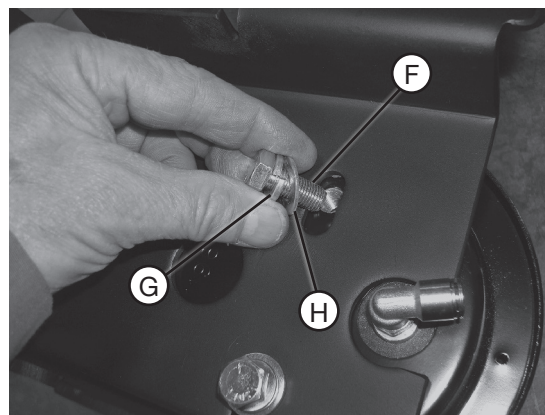

fig. D.14

3. Flip the assembly upside down and set a roll plate on the bottom of the air spring (Fig. D.15).



fig. D.15

4. Install the lower brackets (A) onto the air spring assembly with two 3/8"-16 x 7/8" hex cap screws (F), 3/8" lock washers (G) and 3/8" flat washers (H) (Fig. D.16), making sure that the flanges on the lower bracket face the fitting on the top of the air spring. (Fig. D.17).

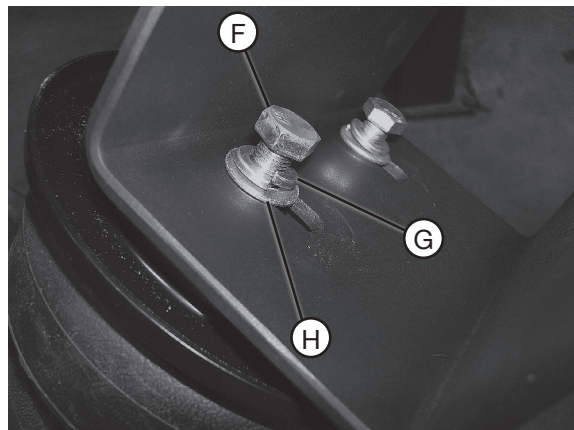
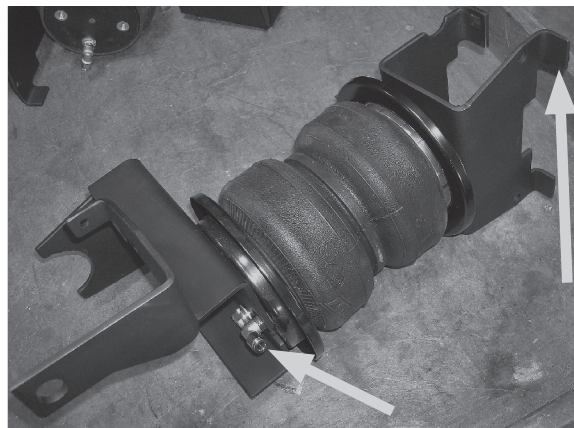

fig. D.16



The flanges on the lower bracket must face the same direction as the fitting on the upper assembly.

fig. D.17

- Figure D.18 shows the driver and passenger side assemblies.

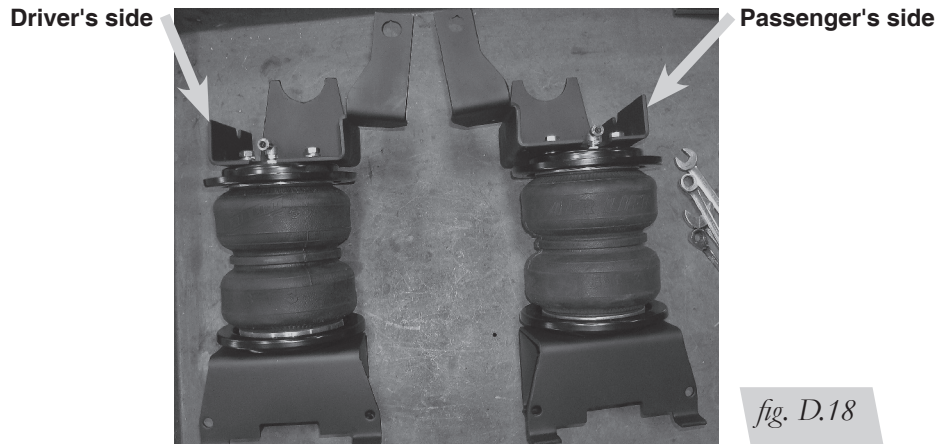
fig. D.18

INSTALLING THE ASSEMBLIES

- Drop the axle down low enough in order to set the assemblies into position onto the axle, just inside the leaf spring, then set the assemblies in place.

NOTE

The air fitting on the assemblies face the outboard (tire side) of the vehicle.

- If necessary, raise the axle up just enough that the upper bracket touches the frame. While raising the axle, align the J-bolt and round U-bolts with the holes in the bracket (Fig. D.19). Attach the upper bracket to the 5th-wheel mounting hole, located on the side of the frame using the M14-1.5 x 40 hex flange bolt (P). Apply medium strength (blue) threadlocker compound to the bolt before inserting in hole.

Install M14 bolt with blue threadlocker compound through the upper bracket and into the existing hole in the frame.

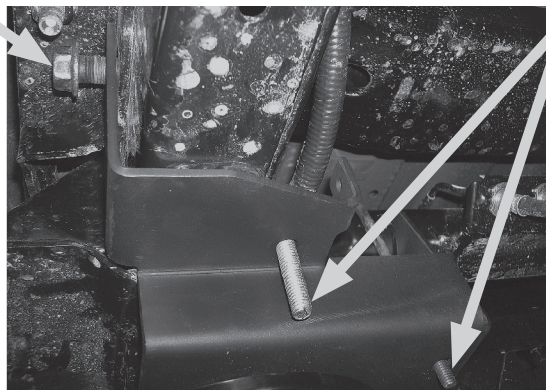

While raising the axle, once the assemblies are in place, align the J-bolt and round U-bolt with the corresponding holes in the upper brackets.

fig. D.19

- Cap the J-bolt and round U-bolt with three 3/8" flat washers (H) and nylon lock nuts (S) (Fig. D.20).

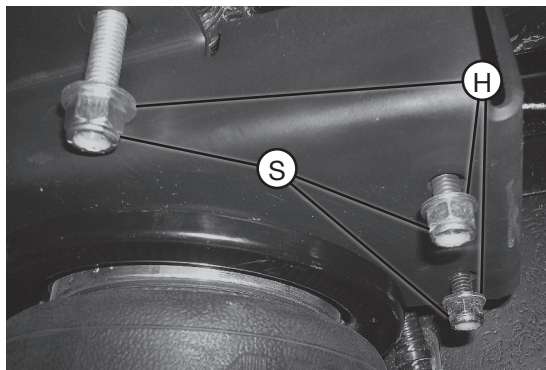
fig. D.20

4. Snug the M14 bolt first, then torque the 3/8" U-bolt and J-bolt evenly to 15 lb.-ft. (20 Nm) Then torque the M14 hardware to 77 lb.-ft. (105 Nm).
5. Attach the lower bracket by inserting the legs of the previously installed U-bolt around the spring perch, through the corresponding holes in the lower bracket (Fig. D.21).

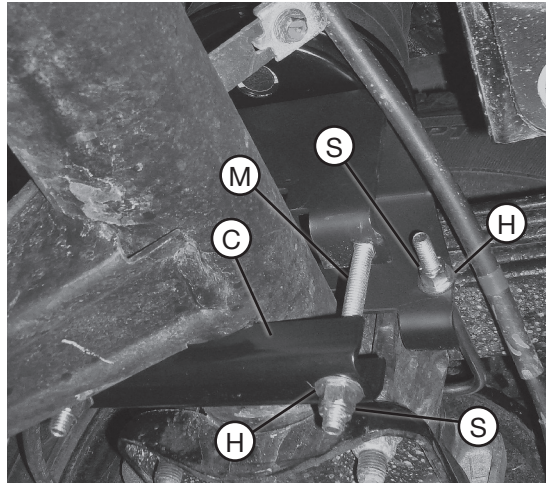
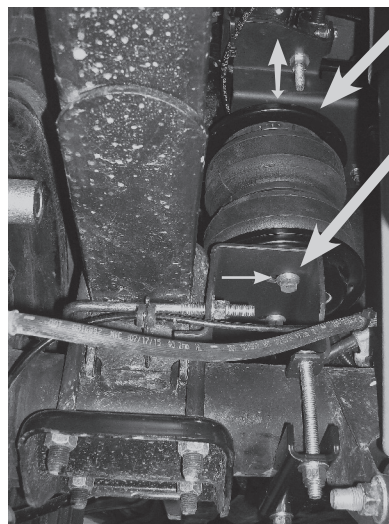

fig. D.21

6. Insert the two 3/8"-16 x 4" carriage bolts (M) through the holes in the lower bracket and install the lower axle clamp bar (C) under the axle. Cap the carriage bolts with two 3/8" flat washers (H) and 3/8"-16 nylon lock nuts (S). Do not tighten at this time.
7. Push the lower bracket up against the stock leaf spring U-bolts, making sure the tabs on the lower bracket are locked around the outside of the U-bolts. Snug the spring perch/lower bracket U-bolt evenly (Do not tighten at this time). Tighten the axle spring clamp evenly until tight, then torque the axle clamp hardware to 15 lb.-ft. (20 Nm). Torque the spring perch/lower bracket hardware to 15 lb.-ft. (20 Nm).
8. In final adjustments, push the lower bellows inboard on the lower bracket and tighten the lower hardware to no more than 20 lb.-ft. (27 Nm) (Fig. D.22).



Push the bellows forward or backward and tighten the mounting hardware.

Push the bellows inboard and tighten the mounting hardware.

fig. D.22

9. Align the upper bellows by moving it forward or backward, then tighten the upper mounting hardware no more than 20 lb.-ft. (27 Nm).
10. Install the P-clamp (J) over the wiring on the driver's side and attach to the upper bracket, with the "P" facing the frame (Fig. D.23). Attach the P clamp with one 1/4"-20 x 3/4" hex head screw (N), two #12 flat washers (Q) and one 1/4" nylon lock nut (R). Tighten securely.

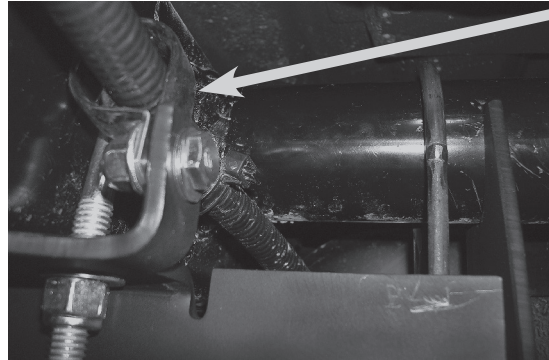

Reattach previously removed wiring onto the upper bracket on the driver's side.

fig. D.23

11. Install the other P-clamp (J) around the passenger's side wiring and ABS line that had been previously removed. Along with the previously removed axle vent tube bracket, attach the P-clamp and wiring to the upper bracket, using the same hardware specified from the driver's side (Fig. D.24). Tighten securely.

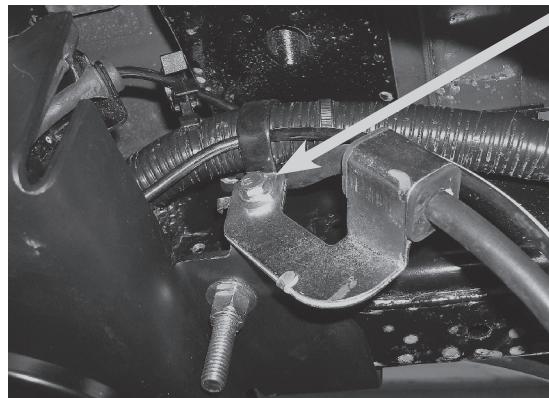

Reattach the previously removed ABS line and axle vent tube bracket on the passenger's side using a P-clamp.

fig. D.24

12. Bend the emergency brake line brackets, located on the axle, forward on both the driver's and passenger's side, forward of the axle, far enough for the line to gain clearance of the lower bracket (Fig. D.25).

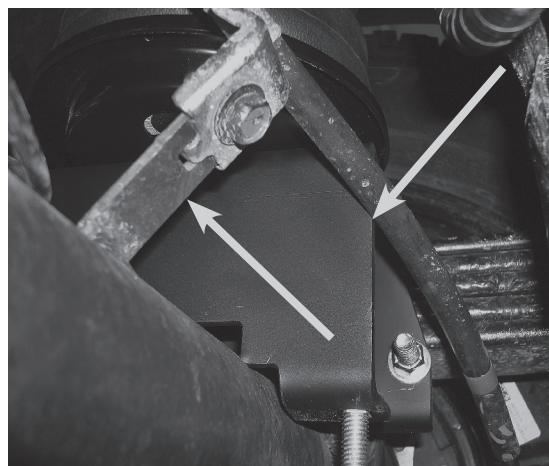

Bend the bracket slightly to gain clearance between the emergency brake line and lower bracket forward of the axle on both sides.

fig. D.25

13. Tie off the ABS line on the passenger side, which was disconnected from the axle bracket, to the axle vent tube with a tie strap (U) (Fig. D.26).

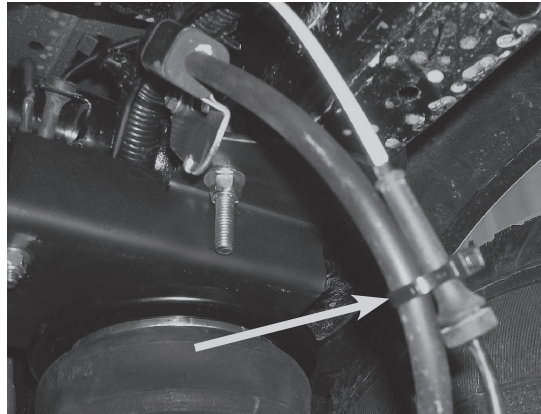

Tie strap the ABS line to the axle vent tube, as shown on the passenger's side.

fig. D.26

14. Tie off the ABS line behind the axle on the driver's side to the soft brake line with a tie strap (U) (Fig. D.27).

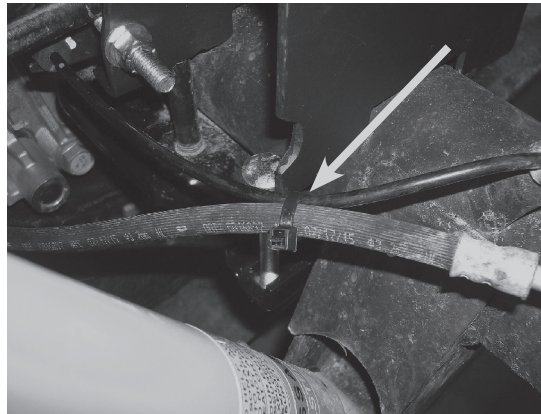

Tie strap the ABS line to the axle vent tube, as shown on the driver's side.

fig. D.27

E. Installing the Air Lines

This section assumes that the system will be controlled with Schrader valves rather than an Air Lift control system. Review the control system installation instructions if using one of those systems. Learn more about Air Lift control systems at www.airliftcompany.com/products/compressor-systems.

1. Choose a convenient location for mounting the inflation valves (Fig. E.1). Popular locations for the inflation valve are:
 - a. The wheel well flanges
 - b. The license plate recess in bumper
 - c. Under the gas cap access door
 - d. Through the license plate

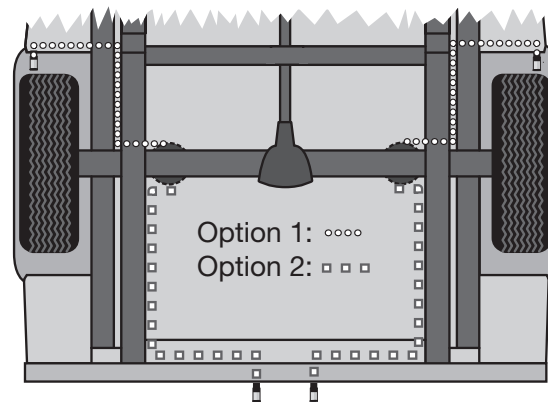

fig. E.1

NOTE

Whatever the chosen location, make sure there is enough clearance around the inflation valves for an air chuck.

2. Drill 5/16" holes to install the inflation valves.
3. If installing dual air lines, cut the air line assembly in two equal lengths.
4. Place a 5/16" nut and star washer on the air valve. Leave enough of the inflation valve in front of the nut to extend through the hole and have room for the rubber washer, flat washer, and 5/16" nut and cap. There should be enough valve exposed after installation – approximately 1/2" – to easily apply a pressure gauge or an air chuck (Fig. E.2).

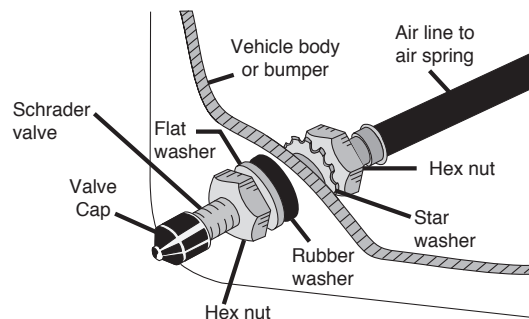

fig. E.2

5. Push the inflation valve through the hole and use the rubber washer, flat washer, and another 5/16" nut to secure it in place. Tighten the nuts to secure the assembly.
6. Route the air line along the frame to the fitting on the air spring (Fig. E.1). Keep AT LEAST 6" of clearance between the air line and the exhaust system. Avoid sharp bends and edges. Use plastic tie straps to secure the air line to fixed points along the chassis. Be sure that the tie straps are tight, but do not pinch the air line. Leave at least 2" of slack to allow for any movement that might pull on the air line.
7. Cut off the air line, leaving approximately 12" of extra air line. A clean square cut will prevent leaks. Insert the air line into the air fitting. This is a push-to-connect fitting. Simply push the air line into the 90° swivel fitting until it bottoms out (9/16" of air line should be in the fitting).

TIPS FOR INSTALLING AIR LINES

When cutting air lines, use a sharp knife or a hose cutter and make clean, square cuts (Fig. D.3). Do not use scissors or wire cutters because these tools may deform the air line, causing it to leak around fittings. Do not cut the lines at an angle.

Do not bend the 1/4" hose at a radius of less than 1" or bend the 3/8" hose at a radius of less than 1 1/2". Do not put side load pressure on fitting. The hose should be straight beyond the fitting for 1" before bending.

Inspect hose for scratches that run lengthwise on hose prior to installation. Contact Air Lift customer service at (800) 248-0892 if the air line is damaged.



Go to air-lift.co/cuttingairline to watch a video demonstrating proper air line cutting.

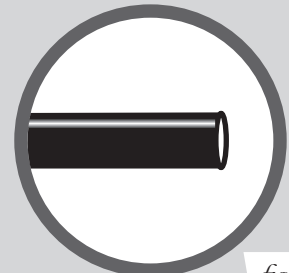

fig. D.3



F. Finished Installation Photos

1. The following images show the finished installation of both sides (Figs. F.1, F.2 & F.3).

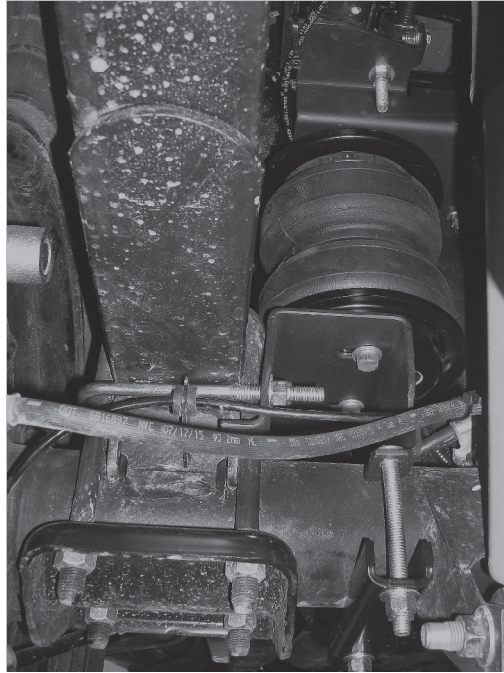

fig. F.1

Figure F.1 shows the rear view of the left (driver) side installation.

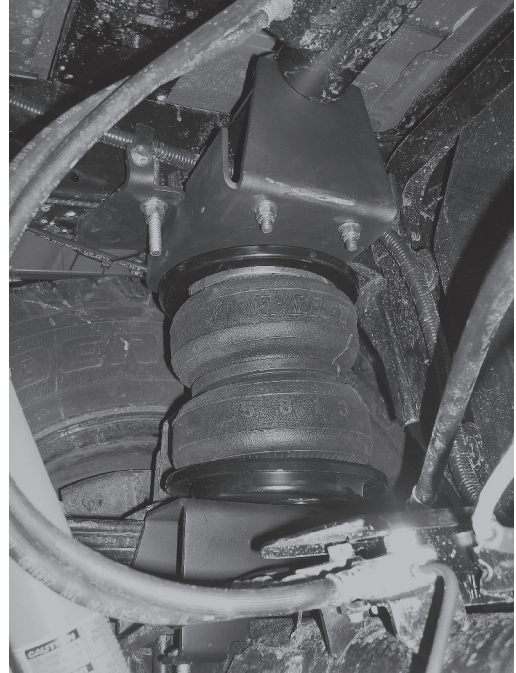

fig. F.2

Figure 2 shows the inside rear view of the driver's side installation.

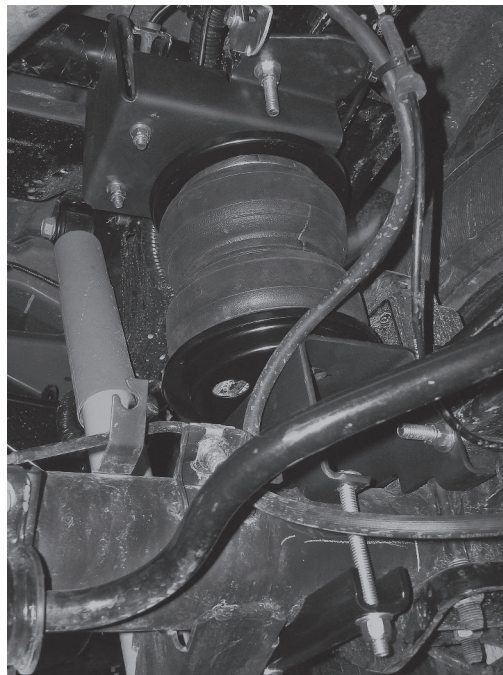

fig. F.3

Figure F.3 shows the right (passenger) side rear view.

G. Before Operating

CHECKING FOR LEAKS

1. Inflate the air spring to 30 PSI.
2. Spray all connections and the inflation valves with a solution of 1/5 liquid dish soap and 4/5 water. Spot leaks easily by looking for bubbles in the soapy water.
3. After the test, deflate the springs to the minimum pressure required to restore the system to normal ride height. Do not deflate to lower than 5 PSI.
4. Check the air pressure again after 24 hours. A 2-4 PSI loss after initial installation is normal. Retest for leaks if the loss is more than 5 PSI.

FIXING LEAKS

1. If there is a problem with the swivel fitting:
 - a. Check the air line connection by deflating the spring and removing the line by pulling the collar against the fitting and pulling firmly on the air line. Trim 1" off the end of the air line. Be sure the cut is clean and square (see Fig. D.1). Reinsert the air line into the push-to-connect fitting.
 - b. Check the threaded connection by tightening the swivel fitting another half turn. If it still leaks, deflate the air spring, remove the fitting, and re-coat the threads with thread sealant. Reinstall by hand tightening as much as possible and then use a wrench for an additional two turns.
2. If there is a problem with the inflation valve:
 - a. Check the valve core by tightening it with a valve core tool.
 - b. Check the air line by removing the air line from the barbed type fitting. Cut the air line off a few inches in front of the fitting and use a pair of pliers or vice grips to pull/twist the air line off of the fitting.



CAUTION

DO NOT CUT OFF THE AIR LINE COMPLETELY AS THIS WILL USUALLY NICK THE BARB AND RENDER THE FITTING USELESS.

3. If the preceding steps have not resolved the problem, call Air Lift customer service at **(800) 248-0892**.

INSTALLATION CHECKLIST

- Clearance test** — Inflate the air springs to 75-90 PSI and make sure there is at least 1/2" clearance from anything that might rub against each sleeve. Be sure to check the tire, brakes, frame, shock absorbers and brake cables.
- Leak test before road test** — Inflate the air springs to 75-90 PSI and check all connections for leaks. All leaks must be eliminated before the vehicle is road tested.
- Heat test** — Be sure there is sufficient clearance from heat sources, at least 6" for air springs and air lines. If a heat shield was included in the kit, install it. If there is no heat shield, but one is required, call Air Lift customer service at **(800) 248-0892**.
- Fastener test** — Recheck all bolts for proper torque.
- Road test** — The vehicle should be road tested after the preceding tests. Inflate the springs to recommended driving pressures. Drive the vehicle 10 miles and recheck for clearance, loose fasteners and air leaks.
- Operating instructions** — If professionally installed, the installer should review the operating instructions with the owner. Be sure to provide the owner with all of the paperwork that came with the kit.

POST-INSTALLATION CHECKLIST

- Overnight leak down test** — Recheck air pressure after the vehicle has been used for 24 hours. If the pressure has dropped more than 5 PSI, then there is a leak that must be fixed. Either fix the leak yourself or return to the installer for service.
- Air pressure requirements** — It is important to understand the air pressure requirements of the air spring system. Regardless of load, the air pressure should always be adjusted to maintain adequate ride height at all times while driving.
- Thirty-day or 500-mile test** — Recheck the air spring system after 30 days or 500 miles, whichever comes first. If any part shows signs of rubbing or abrasion, the source should be identified and moved, if possible. If it is not possible to relocate the cause of the abrasion, the air spring may need to be remounted. If professionally installed, the installer should be consulted. Check all fasteners for tightness.

H. Product Use, Maintenance and Servicing

Minimum Recommended Pressure	Maximum Air Pressure
5 PSI	100 PSI

MAINTENANCE GUIDELINES

NOTE

By following the steps below, vehicle owners will obtain the longest life and best results from their air springs.

CAUTION

FOR SAFETY AND TO PREVENT POSSIBLE DAMAGE TO THE VEHICLE, DO NOT EXCEED MAXIMUM GROSS VEHICLE WEIGHT RATING (GVWR), AS INDICATED BY THE VEHICLE MANUFACTURER. ALTHOUGH THE AIR SPRINGS ARE RATED AT A MAXIMUM INFLATION PRESSURE OF 100 PSI, THE AIR PRESSURE ACTUALLY NEEDED IS DEPENDENT ON LOAD AND GVWR.

1. Check air pressure weekly.
2. Always maintain normal ride height. Never inflate beyond 100 PSI.
3. If you develop an air leak in the system, use a soapy water solution (1/5 liquid dish soap and 4/5 water) to check all air line connections and the inflation valve core before deflating and removing the air spring.
4. Loaded vehicles require at least 25 PSI. A “loaded vehicle” refers to a vehicle with a heavy bed load, a trailer or both. Never exceed GVWR, regardless of air spring, air pressure or other load assist. The springs in this kit will support approximately 40 pounds of load (combined on both springs) for each 1 PSI of pressure. The required air pressure will vary depending on the state of the original suspension. Operating the vehicle below the minimum air spring pressure will void the Air Lift warranty.
5. When increasing load, always adjust air pressure to maintain normal ride height. Increase or decrease pressure from the system as necessary to attain normal ride height for optimal ride and handling. Remember that loads carried behind the axle (including tongue loads) require more leveling force (pressure) than those carried directly over the axle.
6. Always add air to springs in small quantities, checking the pressure frequently.
7. Should it become necessary to raise the vehicle by the frame, make sure the system is at minimum pressure (5 PSI) to reduce the tension on the suspension/ brake components. Use of on-board leveling systems do not require deflation or disconnection.
8. Periodically check the air spring system fasteners for tightness. Also, check the air springs for any signs of rubbing. Realign if necessary.
9. On occasion, give the air springs a hard spray with a garden hose to remove mud, sand, gravel or other debris.

TUNING THE AIR PRESSURE

Pressure determination comes down to three things — level vehicle, ride comfort and stability.

1. Level vehicle

If the vehicle's headlights are shining into the trees or the vehicle is leaning to one side, then it is not level (Fig. H.1). Raise the air pressure to correct either of these problems and level the vehicle.

2. Ride comfort

If the vehicle has a rough or harsh ride it may be due to either too much pressure or not enough (Fig. H.2). Try different pressures to determine the best ride comfort.

3. Stability

Stability translates into safety and should be the priority, meaning the driver may need to sacrifice a perfectly level and comfortable ride. Stability issues include roll control, bounce, dive during braking and sponginess (Fig. H.3). Tuning out these problems usually requires an increase in pressure.

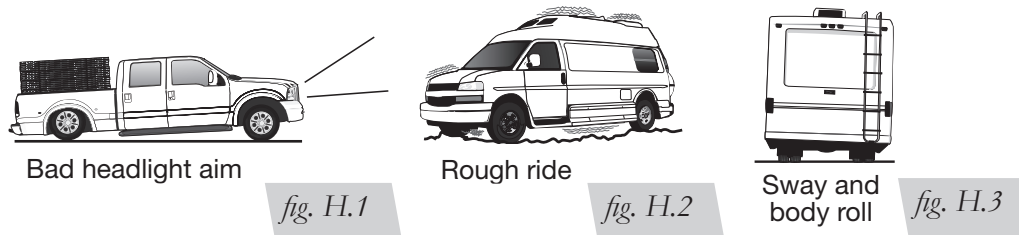

GUIDELINES FOR ADDING AIR

1. Start with the vehicle level or slightly above.
2. When in doubt, always add air.
3. If the front of the vehicle dives while braking, increase the pressure in the front air bags, if equipped.
4. If it is ever suspected that the air bags have bottomed out, increase the pressure. (Fig. H.4)
5. Adjust the pressure up and down to find the best ride.
6. If the vehicle rocks and rolls, adjust the air pressure to reduce movement.
7. It may be necessary to maintain different pressures on each side of the vehicle. Loads such as water, fuel, and appliances will cause the vehicle to be heavier on one side (Fig. H.5). As much as a 50 PSI difference is not uncommon.

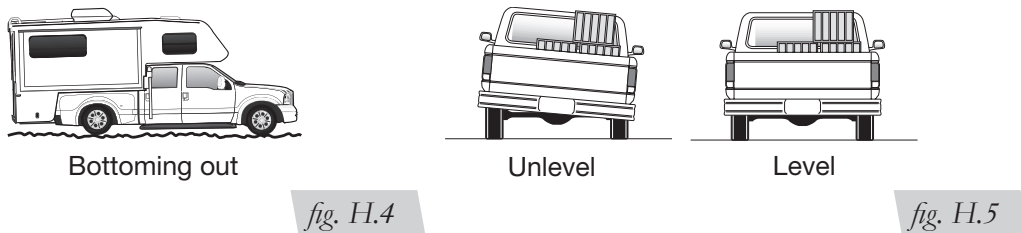

I. Troubleshooting Guide

PROBLEM	CAUSE	SOLUTION
System won't maintain pressure overnight.	Improperly installed air line, air line has holes or cracks.	Leak test the air line connections, the threaded connection into the air spring, and all fittings in the control system.
Air spring or tank leak.	Fitting seal or air line is compromised.	Check to make sure air lines are seated in connectors. Inspect fittings with soapy water. Trim hose or re-seal fitting. Ensure lines are cut straight.
Corner won't raise or air leak develops.	Look for a kink or fold in the air line.	Replace any air line that has been kinked.

FREQUENTLY ASKED QUESTIONS

Q. Will installing air springs increase the weight ratings of a vehicle?

No. Adding air springs will not change the weight ratings (GAWR, GCWR and/or GVWR) of a vehicle. Exceeding the GVWR is dangerous and voids the Air Lift warranty.

Q. Is it necessary to keep air in the air springs at all times and how much pressure will they need?

For LoadLifter 5000 Ultimate, the recommended minimum air pressure is 5 PSI, but it can safely be run at zero air pressure.

Q. Is it necessary to add a compressor system to the air springs?

No. Air pressure can be adjusted with any type of compressor as long as it can produce sufficient pressure to service the springs. Even a bicycle tire pump can be used, but it's a lot of work.

Q. How long should air springs last?

If the air springs are properly installed and maintained they can last indefinitely.

Q. Will raising the vehicle on a hoist for service work damage the air springs?

No. The vehicle can be lifted on a hoist for short-term service work such as tire rotation or oil changes. However, if the vehicle will be on the hoist for a prolonged period of time, support the axle with jack stands in order to take the tension off of the air springs.

Notes



Notes



Limited Warranty and Return Policy

WHAT THIS WARRANTY COVERS

Air Lift Company provides a warranty to the original purchaser of its Load Support Products, for the periods of time listed below, by product line, from the date of original purchase, that the products will be free from defects in workmanship and materials when used on cars and trucks as specified by Air Lift Company and under normal operating conditions, subject to the requirements and exclusions set forth below.

WHAT THIS WARRANTY DOES NOT COVER

The warranty does not apply to products that have been improperly applied, improperly installed, or which have not been maintained in accordance with installation instructions furnished with all products. This warranty does not apply and is void if damage or failure is caused by: accident, abuse, misuse (including but not limited to racing or off-road activities or commercial use), abnormal use, faulty installation, liquid contact, fire, earthquake or other external cause; operating the product outside Air Lift Company’s instructions, specifications or guidelines; or service, alteration, maintenance or repairs performed by anyone other than Air Lift Company to the product from its purchased condition. This warranty also does not apply to: consumable parts, such as batteries; cosmetic damage, including but not limited to scratches or dents; defects caused by normal wear and tear or otherwise due to the normal aging of the product, or if any serial or identification number has been removed or defaced from the product. Air Lift Company reserves the right to change the design of any product without assuming any obligation to modify any product previously manufactured.

LIMITATION OF LIABILITY

To the extent permitted by law, this warranty and the remedies set forth herein are exclusive and in lieu of all other warranties, remedies and conditions, whether oral, written, statutory, express or implied. AIR LIFT COMPANY DISCLAIMS ALL STATUTORY AND IMPLIED WARRANTIES, INCLUDING WITHOUT LIMITATION, WARRANTIES OF MERCHANTABILITY AND FITNESS FOR A PARTICULAR PURPOSE AND WARRANTIES AGAINST HIDDEN OR LATENT DEFECTS TO THE EXTENT PERMITTED BY LAW. To the extent such warranties cannot be disclaimed, such implied warranties shall apply only for the warranty period specified above. Please note that some states do not allow limitation on how long an implied warranty (or condition) lasts. So the above limitation may not apply to you.

Except as provided in this warranty and to the extent permitted by law, Air Lift Company shall not be liable for any direct, special, incidental or consequential damages resulting from any breach of warranty or condition, or arising in connection with the sale, use or repair of air lift products, or under any other legal theory, including but not limited to loss of use, loss of revenue, loss of actual or anticipated profits, loss of the use of money, loss of business, loss of opportunity, loss of goodwill, and loss of reputation. Air Lift Company’s maximum liability shall not in any case exceed the purchase price paid by you for the Air Lift product. Please note that some states do not allow the exclusion or limitation of incidental or consequential damages, so the above limitation or exclusion may not apply to you.

HOW TO GET SERVICE

If a defect in workmanship or materials causes your Air Lift product to become inoperable within the warranty period, before returning any defective product, call Air Lift Company at (800) 248-0892 in the U.S. and Canada (elsewhere, (517) 322-2144) to obtain a Returned Materials Authorization (RMA) number. The consumer shall be responsible for removing (labor charges) the defective product from the vehicle and returning it, shipping costs prepaid, to Air Lift Company for verification. Returns to Air Lift Company must be postage prepaid and sent to: Air Lift Company • 2727 Snow Road • Lansing, MI • 48917. You must prove to the satisfaction of Air Lift Company the date of original purchase of your Air Lift product. You must also enclose the RMA number and a return address. A minimum \$10 shipping and handling charge will apply to all warranty claims. You must also pack the product to minimize the risk of it being damaged in transit. If we receive a product in damaged condition as the result of shipping, we will notify you and you must seek a claim with the shipper.

WHAT AIR LIFT COMPANY WILL DO

If you submit a valid claim to Air Lift Company during the warranty period, Air Lift Company will, at its option, repair your Air Lift product or furnish you with a new or rebuilt product. Air Lift Company will not reimburse you for repairs or replacement parts provided by other parties. Your repaired or replacement Air Lift product will be returned to you (subject to payment of the required warranty claim shipping and handling charge) and it will be covered under the warranty for the balance of the warranty period, if any. When a product or part is replaced, any replacement item becomes your property and the replaced item becomes property of Air Lift Company. You are responsible for installation/reinstallation (labor charges) of the product.

HOW THE LAW RELATES TO THIS WARRANTY

This warranty gives you specific legal rights and you may also have other rights which vary from state to state. By this warranty, Air Lift Company does not limit or exclude your rights except as allowed by law. To fully understand your rights, you should consult the laws of your state.

SPECIFIC LOAD SUPPORT WARRANTY PERIODS BY PRODUCT LINE

LoadLifter 5000™ Ultimate	Lifetime Limited	WirelessAIR™	2 Year Limited
LoadLifter 5000™	Lifetime Limited	WirelessONE™	2 Year Limited
RideControl™	Lifetime Limited	LoadController™ Single and Dual.....	2 Year Limited
Air Lift 1000™	Lifetime Limited	LoadController™ I and II	2 Year Limited
AirCell™	Lifetime Limited	SmartAir™ II	2 Year Limited
SlamAir™	Lifetime Limited	Other Accessories.....	2 Year Limited

Replacement Part Information

If replacement parts are needed, contact the local dealer or call Air Lift customer service at **(800) 248-0892**. Most parts are immediately available and can be shipped the same day.

Contact Air Lift Company customer service at (800) 248-0892 first if:

- Parts are missing from the kit.
- Need technical assistance on installation or operation.
- Broken or defective parts in the kit.
- Wrong parts in the kit.
- Have a warranty claim or question.

Contact the retailer where the kit was purchased:

- If it is necessary to return or exchange the kit for any reason.
- If there is a problem with shipping if shipped from the retailer.
- If there is a problem with the price.

Contact Information

Mailing address	P.O. Box 80167 Lansing, MI 48908-0167
Shipping address for returns	2727 Snow Road Lansing, MI 48917
Phone	Toll free: (800) 248-0892 International: (517) 322-2144
Email	service@airliftcompany.com
Web address	www.airliftcompany.com

Need Help?

Contact Air Lift Company customer service department by calling (800) 248-0892.

For calls from outside the USA or Canada, dial (517) 322-2144.



Thank you for purchasing Air Lift products — the professional installer's choice!

Air Lift Company • 2727 Snow Road • Lansing, MI 48917 or P.O. Box 80167 • Lansing, MI 48908-0167
Toll Free (800) 248-0892 • Local (517) 322-2144 • Fax (517) 322-0240 • www.airliftcompany.com

Printed in
the USA