

# LoadLIFTER™ 5000

by AIR LIFT®

## Kit 57213 Ford Transit

*(Single and Dual Rear Wheel)  
2-Wheel Drive*



## INSTALLATION GUIDE

For maximum effectiveness and safety, please read these instructions completely before proceeding with installation.

*Failure to read these instructions can result in an incorrect installation.*





# TABLE OF CONTENTS

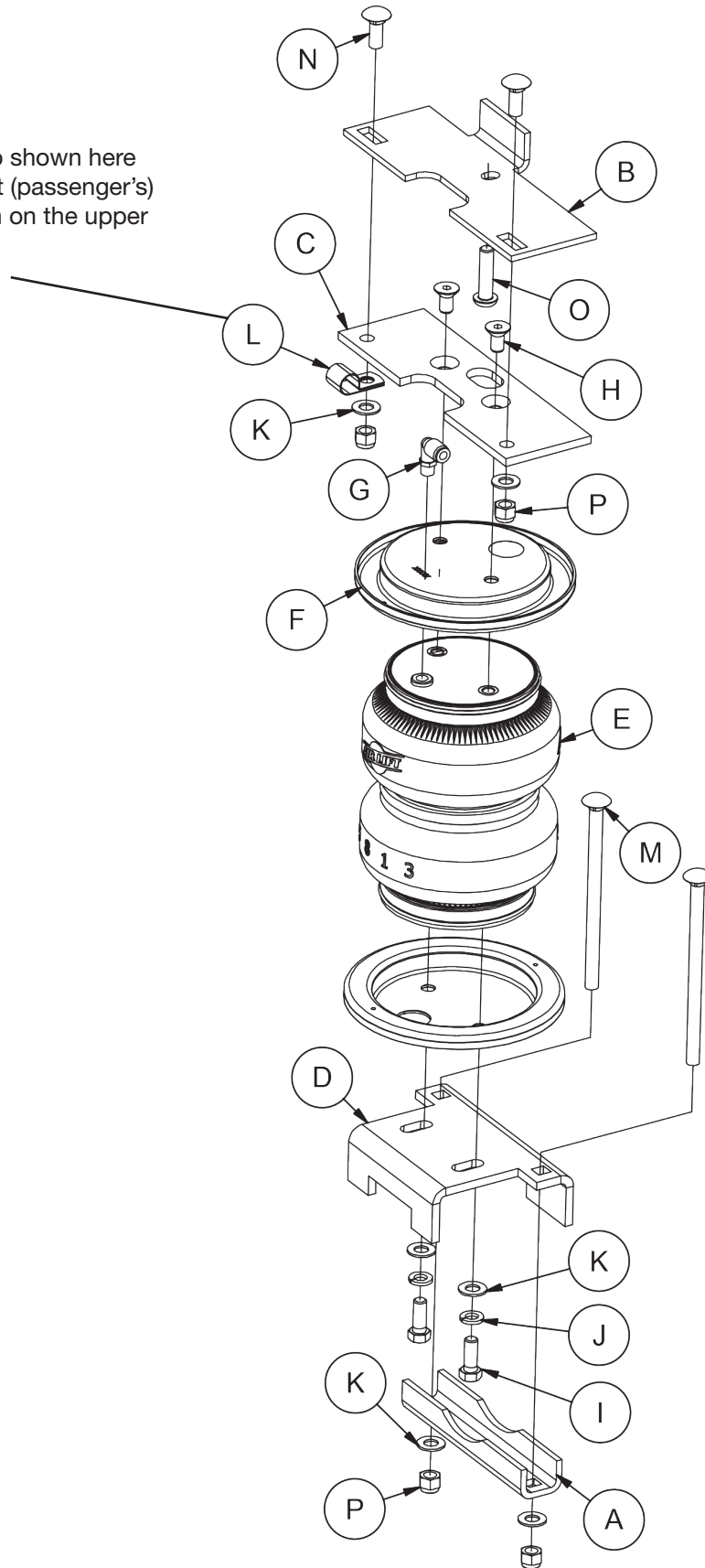


<b>Installation Diagram</b> .....	<b>2</b>
Hardware List .....	3
Tools List .....	3
<b>Introduction</b> .....	<b>4</b>
Important Safety Notice .....	4
Notation Explanation .....	4
<b>Installing the LoadLifter 5000 System</b> .....	<b>5</b>
Getting Started .....	5
Assembling the Air Springs .....	7
Installing the Air Spring Assemblies .....	9
ABS Line Adjustment on Left (Driver's) Side .....	11
<b>Installing the Air Lines</b> .....	<b>12</b>
Installing the Heat Shield .....	14
Tips for Installing the Air Lines .....	15
Push-to-Connect (PTC) Fittings .....	15
Photos of Finished Assemblies .....	16
<b>Before Operating</b> .....	<b>17</b>
Checking for Leaks .....	17
Fixing Leaks .....	17
Installation Checklist .....	18
Post-Installation Checklist .....	18
<b>Product Use, Maintenance and Servicing</b> .....	<b>19</b>
Minimum and Maximum Pressure .....	19
Maintenance Guidelines .....	19
Tuning the Air Pressure .....	20
Guidelines for Adding Air .....	20
<b>Troubleshooting Guide</b> .....	<b>21</b>
Frequently Asked Questions .....	21
<b>Warranty and Returns Policy</b> .....	<b>25</b>
<b>Replacement Information</b> .....	<b>25</b>
<b>Contact Information</b> .....	<b>25</b>



# Installation Diagram

The P-clamp shown here is in the right (passenger's) side position on the upper bracket.



*fig. 1*

# Hardware and Tools Lists

## HARDWARE LIST

Item	Part #	Description.....Qty	Item	Part #	Description.....Qty
A	01531	Clamp bar .....2	M	17133	3/8"-16 x 6" Carriage bolt .....4
B	07954	Frame bracket.....2	N	17361	3/8"-16 x 1.25" Carriage bolt .....4
C	07956	Air spring bracket.....2	O	17366	M10-150 x 35 Button-head screw .....2
D	03906	Lower bracket .....2	P	18435	3/8" Nylon lock nut .....8
E	58437	Air spring.....2	AA*	20086	Air line assembly.....1
F	11951	Roll plate.....4	BB*	10466	Zip tie .....6
G	21848	90° swivel fitting .....2	CC*	21230	Valve cap .....2
H	17215	3/8"-24 x 7/8" flat head screw .....4	DD*	18501	5/16" flat washer .....2
I	17203	3/8"-24 x 7/8" hex cap screw.....4	EE*	21234	Rubber washer.....2
J	18427	3/8" lock washer.....4	FF*	18401	Star washer.....2
K	18444	3/8" flat washer .....12	GG*	21233	5/16" hex nut.....4
L	10778	P clamp.....2	*Not shown in fig. 1.		



Missing or damaged parts? Call Air Lift customer service at (800) 248-0892 for a replacement part.

## TOOLS LIST

Description..... Qty	Description..... Qty
Hoist or floor jacks ..... 1	#6 hex wrench (socket if available) ..... 1
Safety stands..... 2	7/32" hex wrench (socket if available) ..... 1
Safety glasses ..... 1	5/16" drill bit (very sharp)..... 1
Torque wrench..... 1	Heavy duty drill..... 1
Standard open-end combo wrenches..... 1	Hose cutter, razor blade, or sharp knife..... 1
Medium size crescent wrench ..... 1	Air compressor or compressed air source..... 1
Ratchet ..... 1	Spray bottle with dish soap/water solution ..... 1
Metric and standard sockets..... 1	

# Introduction

The purpose of this publication is to assist with the installation, maintenance and troubleshooting of the LoadLifter 5000 air spring kit. LoadLifter 5000 utilizes sturdy, reinforced, commercial-grade single- or double-bellows (depending on the kit). The bellows are manufactured like a tire with layers of rubber and cords that control growth. LoadLifter 5000 kits are recommended for most 3/4 and 1 ton pickups and SUVs with leaf springs, and provide up to 5,000 pounds of load-leveling support with air adjustability from 5-100 PSI.

It is important to read and understand the entire installation guide before beginning installation or performing any maintenance, service or repair. The information here includes a hardware list, tool list, step-by-step installation information, maintenance guidelines and operating tips.

Air Lift Company reserves the right to make changes and improvements to its products and publications at any time. For the latest version of this manual, contact Air Lift Company at (800) 248-0892 or visit our website at [www.airliftcompany.com](http://www.airliftcompany.com).

## IMPORTANT SAFETY NOTICE

The installation of this kit does not alter the gross vehicle weight rating (GVWR) or payload of the vehicle. Check your vehicle's owner's manual and do not exceed the maximum load listed for your vehicle.

**Gross vehicle weight rating:** The maximum allowable weight of the fully loaded vehicle (including passengers and cargo). This number — along with other weight limits, as well as tire, rim size and inflation pressure data — is shown on the vehicle's Safety Compliance Certification Label.

**Payload:** The combined, maximum allowable weight of cargo and passengers that the truck is designed to carry. Payload is GVWR minus the base curb weight.

## NOTATION EXPLANATION

Hazard notations appear in various locations in this publication. Information which is highlighted by one of these notations must be observed to help minimize risk of personal injury or possible improper installation which may render the vehicle unsafe. Notes are used to help emphasize areas of procedural importance and provide helpful suggestions. The following definitions explain the use of these notations as they appear throughout this guide.

### DANGER

INDICATES IMMEDIATE HAZARDS WHICH WILL RESULT IN SEVERE PERSONAL INJURY OR DEATH.

### WARNING

INDICATES HAZARDS OR UNSAFE PRACTICES WHICH COULD RESULT IN SEVERE PERSONAL INJURY OR DEATH.

### CAUTION

INDICATES HAZARDS OR UNSAFE PRACTICES WHICH COULD RESULT IN DAMAGE TO THE MACHINE OR MINOR PERSONAL INJURY.

## NOTE

*Indicates a procedure, practice or hint which is important to highlight.*

# Installing the LoadLifter 5000 System

## GETTING STARTED



COMPRESSED AIR CAN CAUSE INJURY AND DAMAGE TO THE VEHICLE AND PARTS IF IT IS NOT HANDLED PROPERLY. FOR YOUR SAFETY, DO NOT TRY TO INFLATE THE AIR SPRINGS UNTIL THEY HAVE BEEN PROPERLY SECURED TO THE VEHICLE.

1. Raise the vehicle and support it, using jack stands or equivalent, so that the axle can be safely dropped away from the frame (fig. 2). This will need to be done in order for the air spring assembly to be positioned between the axle and frame.

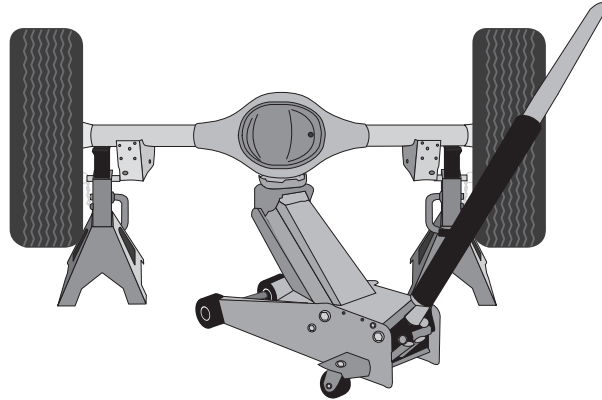


fig. 2

2. Unbolt and remove the stock jounce bumpers from under the frame rails on both sides (figs. 3 & 4). This is a necessary step to install the kit.

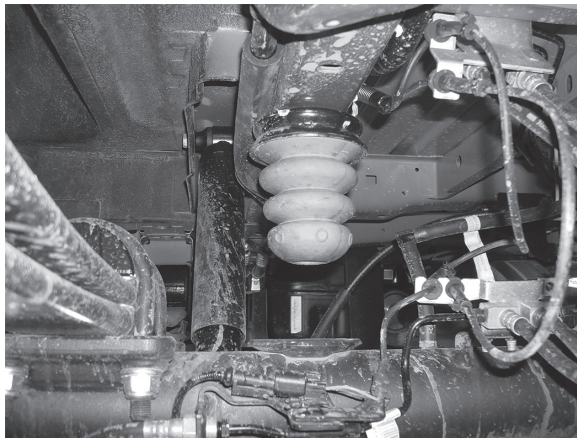
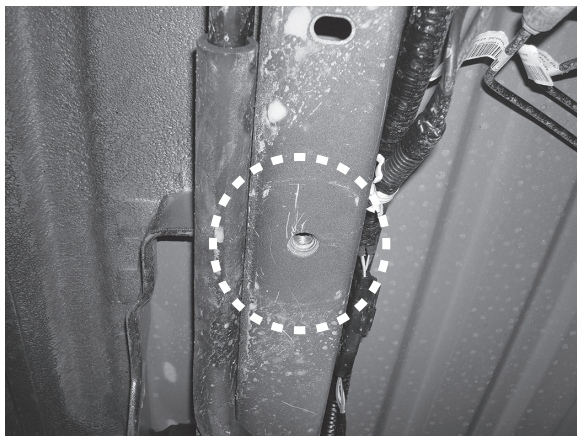


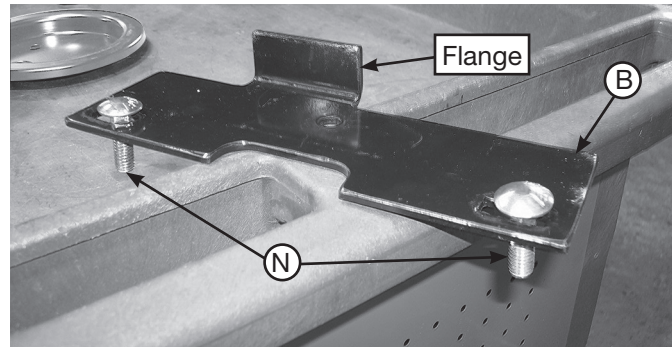
fig. 3



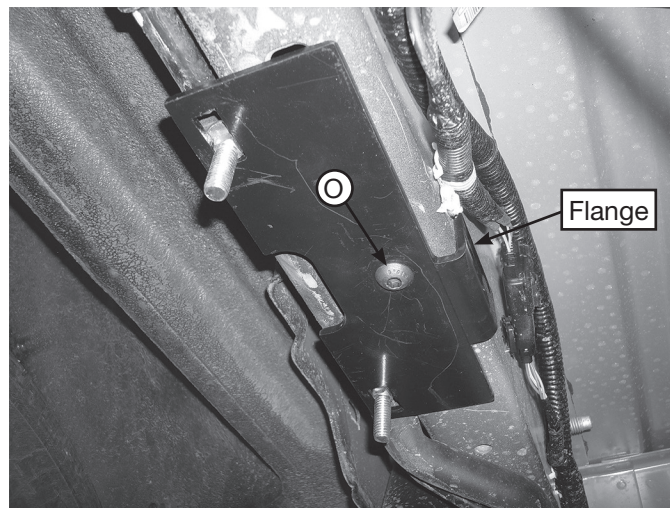
Driver's side shown with jounce bumper removed.

fig. 4

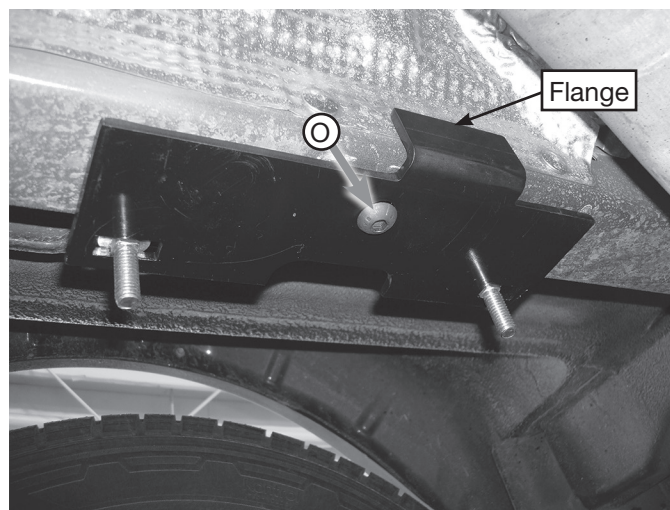
1. Insert two 3/8"-16 x 1.25" carriage bolts (N) through the frame bracket (B). The heads of the bolts should be on the flange side of the bracket (fig. 5).


*fig. 5*

2. Install the upper frame bracket assembly onto the frame using the M10-150 x 35 button head screw (O) making sure the flange on the bracket is on the inside of the frame rail and pointing up (figs. 6 & 7). Push the flange on the bracket up against the frame and torque screw to 30 lb.-ft. (41Nm)



Left  
(driver's)  
side shown.

*fig. 6*


Right  
(passenger's)  
side shown.

*fig. 7*



## ASSEMBLING THE AIR SPRINGS

1. Set a roll plate (F) over the top of the air spring (E) (fig. 8).

### NOTE

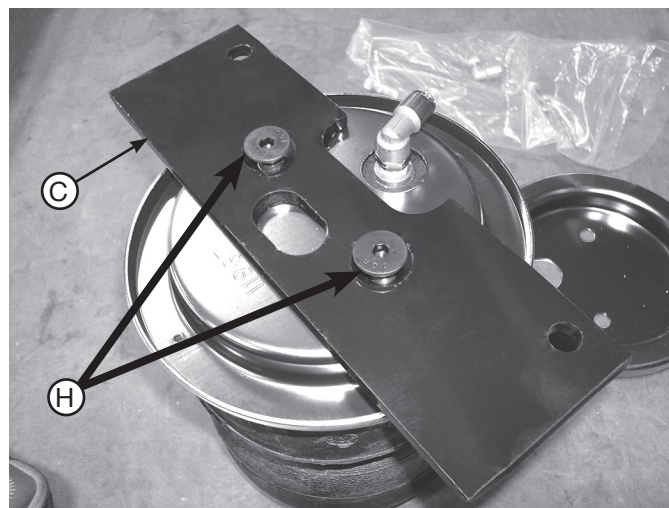
*The radius (rounded) edge of the roll plate (F) will be towards the air spring, so that the air spring is seated inside both roll plates.*

2. Install the 90° swivel fitting (G) into the top of the air spring, finger-tight plus 1 1/2 turns.



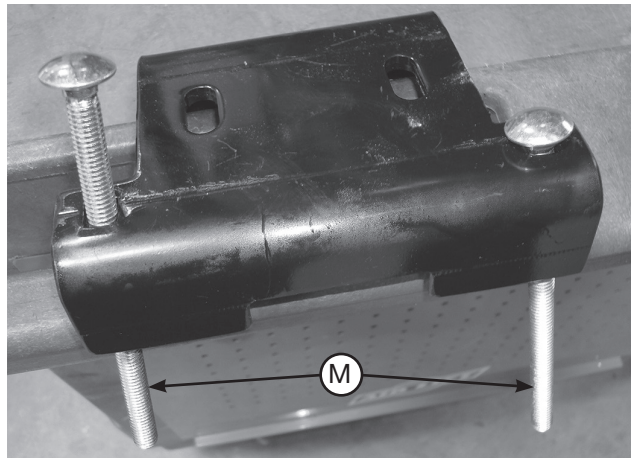
*fig. 8*

3. Set the air spring bracket (C) over the air spring and roll plate and attach with the 3/8"-24 x 7/8" flat-head screws (H) (fig. 9). Torque to no more than 20 lb.-ft. (27Nm). Repeat for the other air spring.



*fig. 9*

1. Insert two 3/8"-13 x 6" carriage bolts (M) through the lower bracket (fig. 10). Assemble the lower bracket onto the air spring assembly so the carriage bolts are on the opposite side of the fittings (fig. 11). Leave them loose at this time. Attach the lower bracket to the air spring assembly with two 3/8"-24 x 7/8" hex cap screws (I), two 3/8" lock washers (J) and two 3/8" flat washers (K) (fig. 12). Leave them loose at this time.

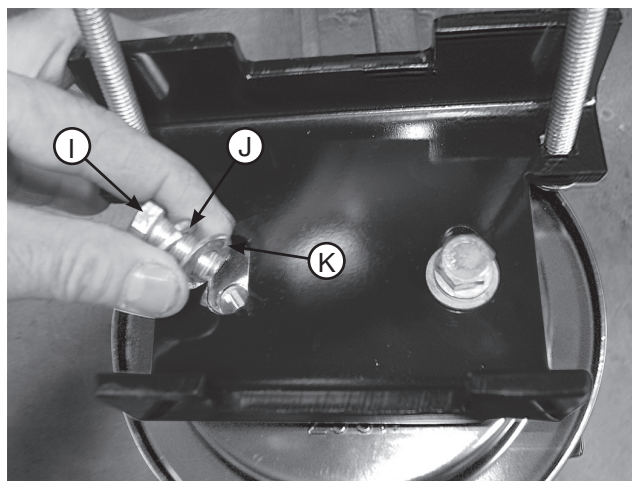


*fig. 10*



Attach the lower brackets so the carriage bolts are opposite of the fitting on the air spring assembly.

*fig. 11*



*fig. 12*

## INSTALLING THE AIR SPRING ASSEMBLIES

1. If not already done, lower the axle enough for clearance to install the assemblies into position.
2. Set the left (driver's) and right (passenger's) side assemblies into position making sure that the long carriage bolt in the rear of the lower bracket, fits between the brake/ABS lines and the axle (fig. 13).

### NOTE

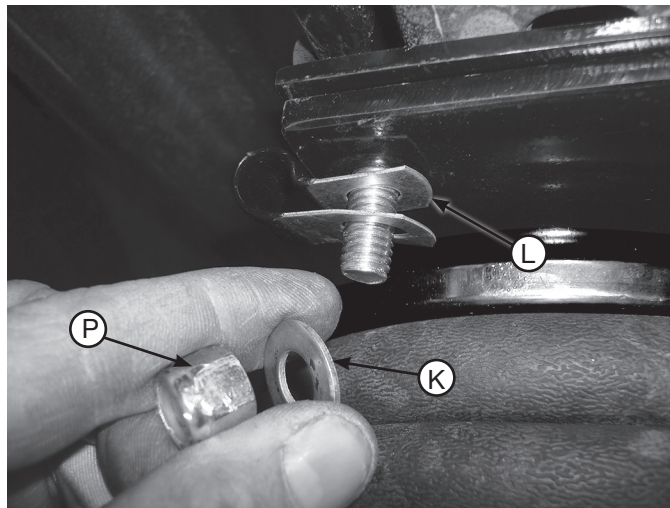
*The lower bracket will be nested over the jounce bumper strike plate.*



Left side shown: set one of the assemblies into position making sure that the carriage bolt goes in between the brake/ABS lines and the axle as shown.

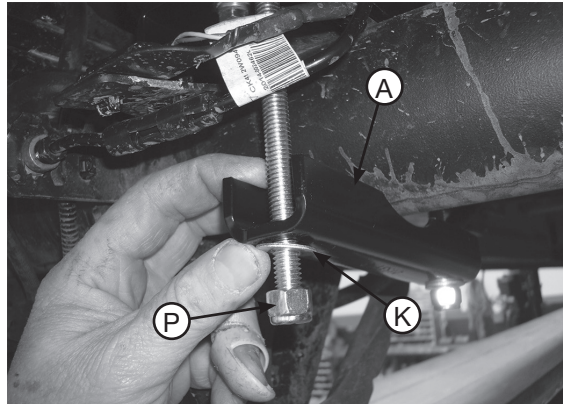
*fig. 13*

3. Raise the axle or lower the body of the vehicle making sure that the carriage bolts —previously installed in the frame bracket — nests into the holes of the air spring bracket (fig. 14). On the back carriage bolts only, it will be necessary to install the P clamps (L) on both sides of the assemblies (the left (driver's) and right (passenger's)). Cap all the carriage bolts with 3/8" flat washers (K) and a 3/8" nylon lock nut (P). Leave them loose at this time.



*fig. 14*

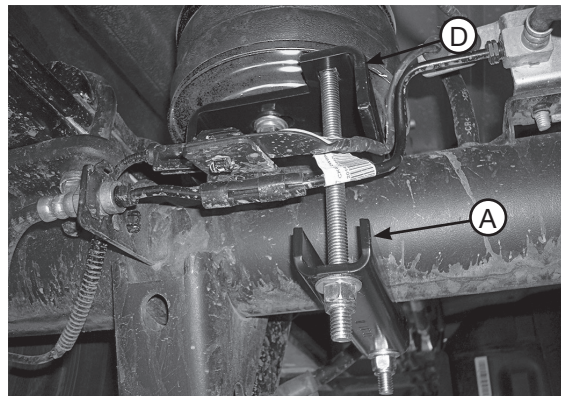
1. Set the axle clamp bar (A) over the long carriage bolts onto the lower bracket, under the axle and cap with two 3/8" flat washers (K) and a 3/8" nylon lock nut (P) (fig. 15). Leave loose at this time.


*fig. 15*

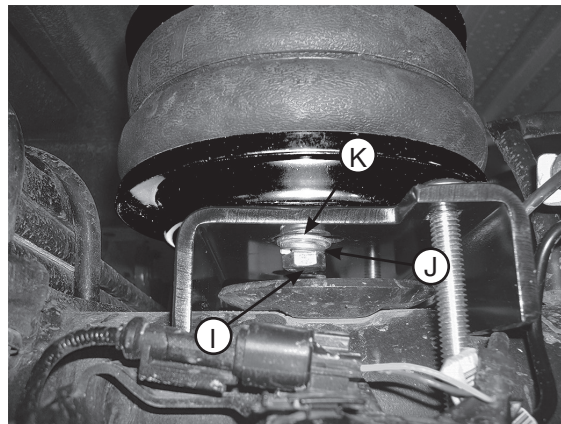
2. The air spring bracket is slotted so that it can be adjusted forward or rearward. Move the air spring assembly so that the air spring is parallel to the upper and lower bracket. Torque the upper hardware to 15 lb.-ft. (20Nm).
3. Once the lower bracket (D) is parallel to the upper bracket, the axle clamp bar (A) on the lower bracket can be torqued evenly to 10 lb.-ft. (14Nm) (fig. 16).

**NOTE**

*It may be necessary to pull the brake line away from the carriage bolt slightly on the right hand side to gain clearance so the line will not rub on the bolt.*

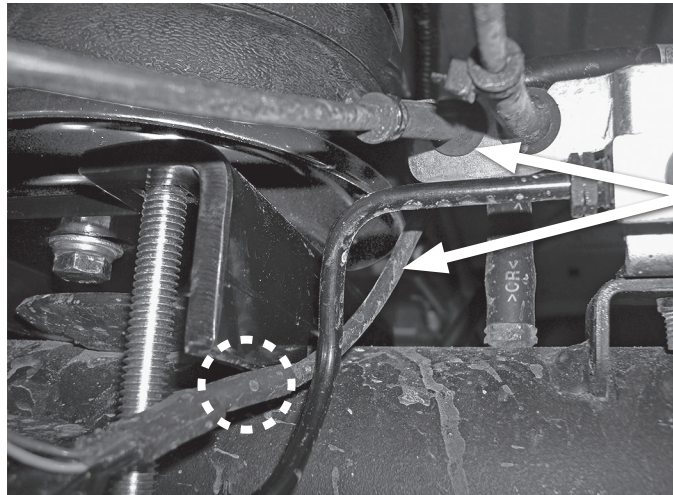

*fig. 16*

4. Once the upper and lower brackets are tight, it will be necessary to tighten the lower air spring mounting hardware on the lower brackets. Slide the bellows along the slots of the lower bracket for the final alignment of the air spring and torque the lower mounting hardware to no more than 20 lb.-ft. (27Nm) (fig. 17).


*fig. 17*

## ABS LINE ADJUSTMENT ON LEFT (DRIVER'S) SIDE

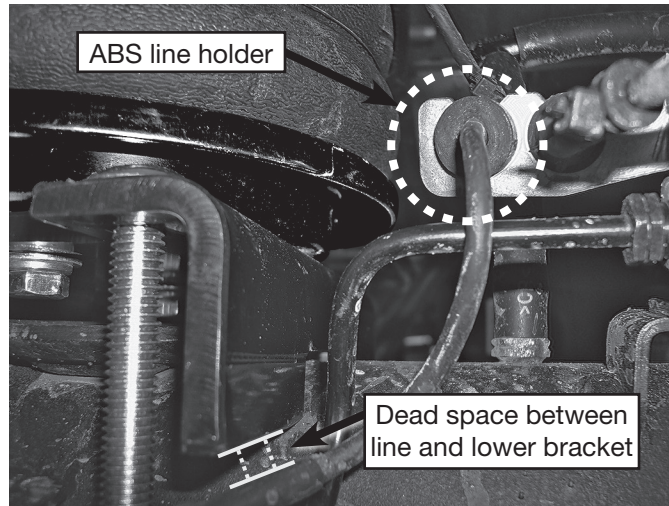
1. On the driver's side behind the axle, the ABS line will need to be adjusted so that it will not rub on the lower bracket (fig. 18).



The ABS line on the left (driver's) side will need to be moved so that it does not rub on the lower bracket.

*fig. 18*

2. To do this just pull the line out of the holder on the axle and rotate it 180°, then push it back into the holder (fig. 19). This will change the position of the line so that it will not come in contact with the lower bracket.



*fig. 19*

# Installing the Air Lines

This section explains how to set up the air spring kit to be controlled with Schrader valves and a separate compressed air source. An on-board air compressor system allows for hassle-free control of the air springs. Learn more about Air Lift control systems at [www.airliftcompany.com/products/compressor-systems](http://www.airliftcompany.com/products/compressor-systems).

1. Choose a convenient location for mounting the inflation valves (fig. 20). Popular locations for the inflation valve are:
  - a. The wheel well flanges
  - b. The license plate recess in bumper
  - c. Under the gas cap access door
  - d. Through the license plate

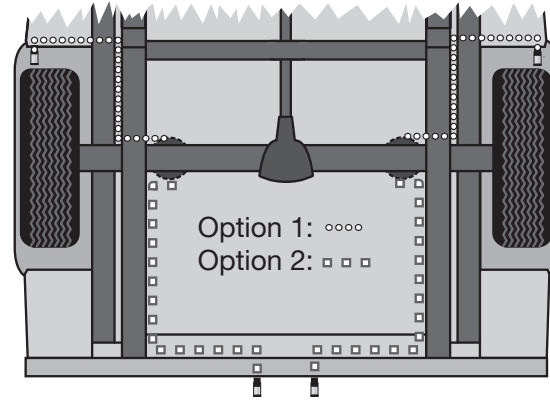


fig. 20

## NOTE

Whatever the chosen location, make sure there is enough clearance around the inflation valves for an air chuck.

2. Drill 5/16" holes to install the inflation valves.
3. Cut the air line assembly in two equal lengths.
4. Place a 5/16" nut and star washer on the air valve. Leave enough of the inflation valve in front of the nut to extend through the hole and have room for the rubber washer, flat washer, and 5/16" nut and cap. There should be enough valve exposed after installation –

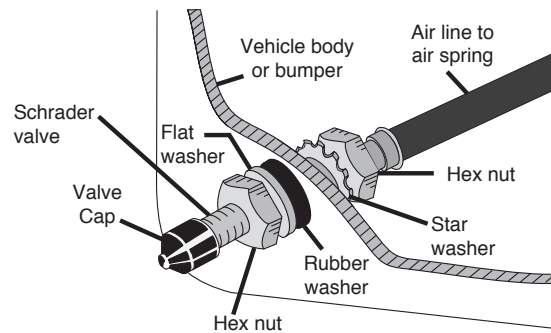


fig. 21

- approximately 1/2" – to easily apply a pressure gauge or an air chuck (fig. 21).
5. Push the inflation valve through the hole and use the rubber washer, flat washer, and another 5/16" nut to secure it in place. Tighten the nuts to secure the assembly.
6. Route the air line along the frame to the fitting on the air spring. Keep AT LEAST 6" of clearance between the air line and the exhaust system. Avoid sharp bends and edges. Use zip ties to secure the air line to fixed points along the chassis. Be sure that the zip ties are tight, but do not pinch the air line. Leave at least 2" of slack to allow for any movement that might pull on the air line.
7. Cut off the air line, leaving approximately 12" of extra air line. A clean square cut will prevent leaks. Insert the air line into the air fitting. This is a push-to-connect fitting.

## TECH TIP

Wiggle the hose back and forth while inserting to make sure the hose bottoms out in the fitting to obtain a good seal.

- 8. Route the air line through the P-clamp that was installed in step 3 of Installing the Air Spring Assemblies (fig. 22).

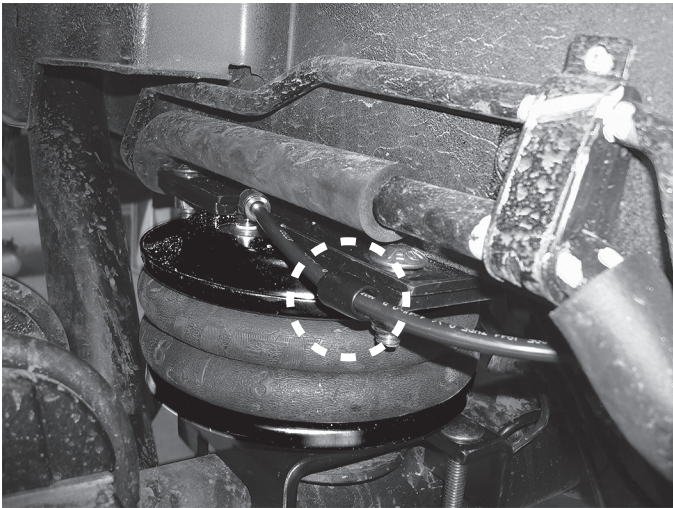
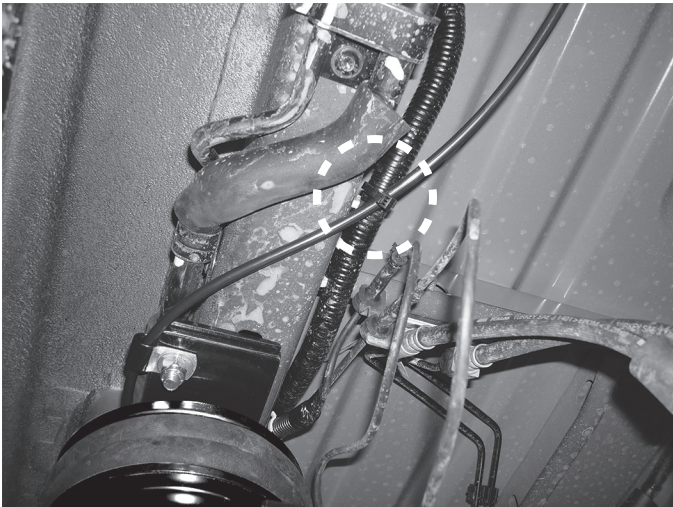


fig. 22

- 9. If the vehicle is equipped with a rear HVAC system, use a zip tie to keep the air line away from this line (fig 23).



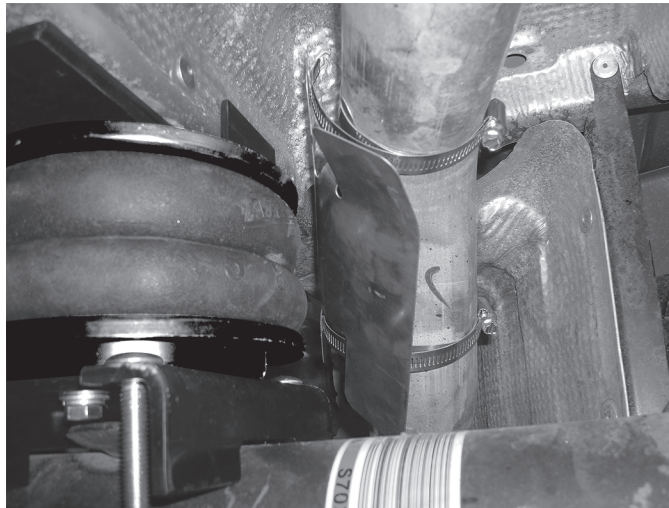
Tie off airline so as not to come in contact with HVAC lined if so equipped.

fig. 23

## INSTALLING THE HEAT SHIELD

**NOTE**

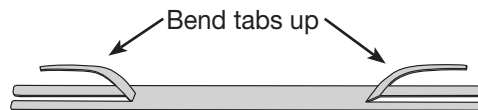
*Finished photo of heat shield installed on right-side (passenger's) exhaust (fig. 24).*



Forward view of the axle showing the heat shield in position on the exhaust.

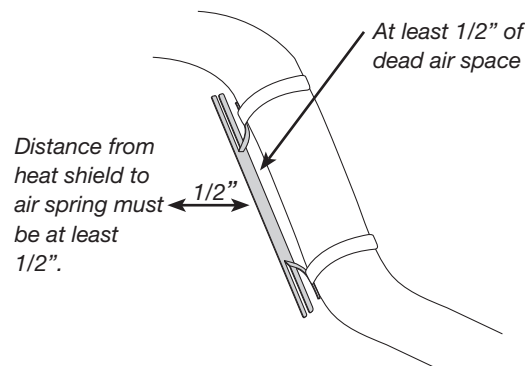
*fig. 24*

1. Bend the tabs on the heat shield to provide a 1/2" dead air space between exhaust pipe and heat shield (fig. 25).



*fig. 25*

2. Attach the heat shield to the exhaust pipe using the clamps (fig. 26). Bend the heat shield for maximum clearance to the air spring.



*fig. 26*



### TIPS FOR INSTALLING AIR LINES

When cutting air lines, use a sharp knife or a hose cutter and make clean, square cuts (Fig. 27). Do not use scissors or wire cutters because these tools may deform the air line, causing it to leak around fittings. Do not cut the lines at an angle. Do not bend the 1/4" hose at a radius of less than 1" or bend the 3/8" hose at a radius of less than 1 1/2". Do not put side load pressure on fitting. The hose should be straight beyond the fitting for 1" before bending. Inspect hose for scratches that run lengthwise on hose prior to installation. Contact Air Lift customer service at (800) 248-0892 if the air line is damaged.

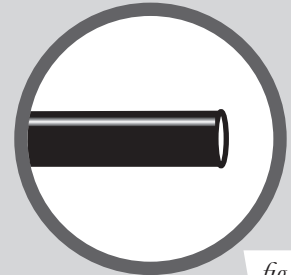


fig. 27



Go to [air-lift.co/cuttingairline](http://air-lift.co/cuttingairline) to watch a video demonstrating proper air line cutting.

### PUSH-TO-CONNECT (PTC) FITTINGS

Air lines should be pushed into the push-to-connect fittings firmly, with a slight side-to-side rotational twist. Check the connection by pulling on each line to verify a robust connection.

**NOTE**

To release the air line from the connection (fig. 28), first release all air from the system. Push in on the air line (step 1), push the collar in (step 2), and with the collar depressed, pull the air line out of the fitting (step 3).

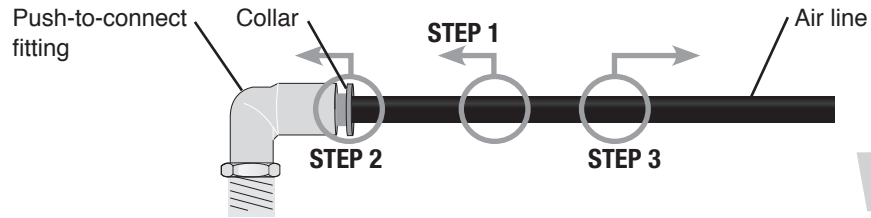
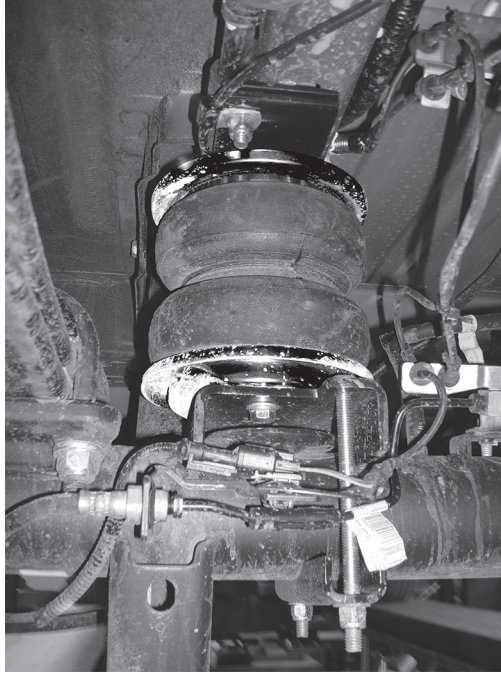


fig. 28

## PHOTOS OF FINISHED ASSEMBLIES

1. Safely remove the jack stands by lowering or raising the vehicle.
2. Figure 29 shows the rear view of the left (driver's side) completed installation.



*fig. 29*

3. Figure 30 shows the rear view of the right (passenger's side) completed installation.



*fig. 30*

# Before Operating

## CHECKING FOR LEAKS

1. Inflate the air spring to 30 PSI.
2. Spray all connections and the inflation valves with a solution of 1/5 liquid dish soap and 4/5 water. Spot leaks easily by looking for bubbles in the soapy water.
3. After the test, deflate the springs to the minimum pressure required to restore the system to normal ride height. Do not deflate to lower than 5 PSI.
4. Check the air pressure again after 24 hours. A 2-4 PSI loss after initial installation is normal. Retest for leaks if the loss is more than 5 PSI.

## FIXING LEAKS

1. If there is a problem with the swivel fitting:
  - a. Check the air line connection by deflating the spring and removing the line by pulling the collar against the fitting and pulling firmly on the air line. Trim 1" off the end of the air line. Be sure the cut is clean and square (see Fig. 27). Reinsert the air line into the push-to-connect fitting.
  - b. Check the threaded connection by tightening the swivel fitting another half turn. If it still leaks, deflate the air spring, remove the fitting, and re-coat the threads with thread sealant. Reinstall by hand tightening as much as possible and then use a wrench for an additional two turns.
2. If there is a problem with the inflation valve:
  - a. Check the valve core by tightening it with a valve core tool.
  - b. Check the air line by removing the air line from the barbed type fitting. Cut the air line off a few inches in front of the fitting and use a pair of pliers or vice grips to pull/twist the air line off of the fitting.



**CAUTION**

**DO NOT CUT OFF THE AIR LINE COMPLETELY AS THIS WILL USUALLY NICK THE BARB AND RENDER THE FITTING USELESS.**

3. If the preceding steps have not resolved the problem, call Air Lift customer service at **(800) 248-0892**.

## INSTALLATION CHECKLIST

- Clearance test** — Inflate the air springs to 75-90 PSI and make sure there is at least 1/2" clearance from anything that might rub against each sleeve. Be sure to check the tire, brakes, frame, shock absorbers and brake cables.
- Leak test before road test** — Inflate the air springs to 75-90 PSI and check all connections for leaks. All leaks must be eliminated before the vehicle is road tested.
- Heat test** — Be sure there is sufficient clearance from heat sources, at least 6" for air springs and air lines. If a heat shield was included in the kit, install it. If there is no heat shield, but one is required, call Air Lift customer service at **(800) 248-0892**.
- Fastener test** — Recheck all bolts for proper torque.
- Road test** — The vehicle should be road tested after the preceding tests. Inflate the springs to recommended driving pressures. Drive the vehicle 10 miles and recheck for clearance, loose fasteners and air leaks.
- Operating instructions** — If professionally installed, the installer should review the operating instructions with the owner. Be sure to provide the owner with all of the paperwork that came with the kit.

## POST-INSTALLATION CHECKLIST

- Overnight leak down test** — Recheck air pressure after the vehicle has been used for 24 hours. If the pressure has dropped more than 5 PSI, then there is a leak that must be fixed. Either fix the leak yourself or return to the installer for service.
- Air pressure requirements** — It is important to understand the air pressure requirements of the air spring system. Regardless of load, the air pressure should always be adjusted to maintain adequate ride height at all times while driving.
- Thirty-day or 500-mile test** — Recheck the air spring system after 30 days or 500 miles, whichever comes first. If any part shows signs of rubbing or abrasion, the source should be identified and moved, if possible. If it is not possible to relocate the cause of the abrasion, the air spring may need to be remounted. If professionally installed, the installer should be consulted. Check all fasteners for tightness.

# Product Use, Maintenance and Servicing

Minimum Recommended Pressure	Maximum Air Pressure
5 PSI	100 PSI

## MAINTENANCE GUIDELINES

### NOTE

*By following the steps below, vehicle owners will obtain the longest life and best results from their air springs.*



### CAUTION

FOR SAFETY AND TO PREVENT POSSIBLE DAMAGE TO THE VEHICLE, DO NOT EXCEED MAXIMUM GROSS VEHICLE WEIGHT RATING (GVWR), AS INDICATED BY THE VEHICLE MANUFACTURER. ALTHOUGH THE AIR SPRINGS ARE RATED AT A MAXIMUM INFLATION PRESSURE OF 100 PSI, THE AIR PRESSURE ACTUALLY NEEDED IS DEPENDENT ON LOAD AND GVWR.

1. Check air pressure weekly.
2. Always maintain normal ride height. Never inflate beyond 100 PSI.
3. If the system develops an air leak, use a soapy water solution (1/5 liquid dish soap and 4/5 water) to check all air line connections and the inflation valve core before deflating and removing the air spring.
4. Loaded vehicles require at least 25 PSI. A “loaded vehicle” refers to a vehicle with a heavy bed load, a trailer or both. Never exceed GVWR, regardless of air spring, air pressure or other load assist. The springs in this kit will support approximately 40 pounds of load (combined on both springs) for each 1 PSI of pressure. The required air pressure will vary depending on the state of the original suspension. Operating the vehicle below the minimum air spring pressure will void the Air Lift warranty.
5. When increasing load, always adjust air pressure to maintain normal ride height. Increase or decrease pressure from the system as necessary to attain normal ride height for optimal ride and handling. Remember that loads carried behind the axle (including tongue loads) require more leveling force (pressure) than those carried directly over the axle.
6. Always add air to springs in small quantities, checking the pressure frequently.
7. Should it become necessary to raise the vehicle by the frame, make sure the system is at minimum pressure (5 PSI) to reduce the tension on the suspension/ brake components. Use of on-board leveling systems do not require deflation or disconnection.
8. Periodically check the air spring system fasteners for tightness. Also, check the air springs for any signs of rubbing. Realign if necessary.
9. On occasion, give the air springs a hard spray with a garden hose to remove mud, sand, gravel or other debris.

## TUNING THE AIR PRESSURE

Pressure determination comes down to three things — level vehicle, ride comfort and stability.

### 1. Level vehicle

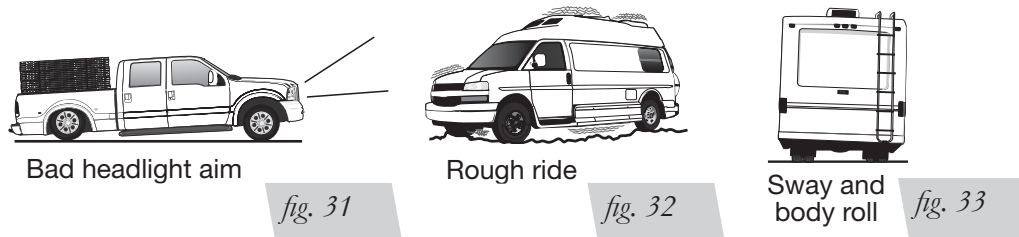
If the vehicle's headlights are shining into the trees or the vehicle is leaning to one side, then it is not level (fig. 31). Raise the air pressure to correct either of these problems and level the vehicle.

### 2. Ride comfort

If the vehicle has a rough or harsh ride it may be due to either too much pressure or not enough (fig. 32). Try different pressures to determine the best ride comfort.

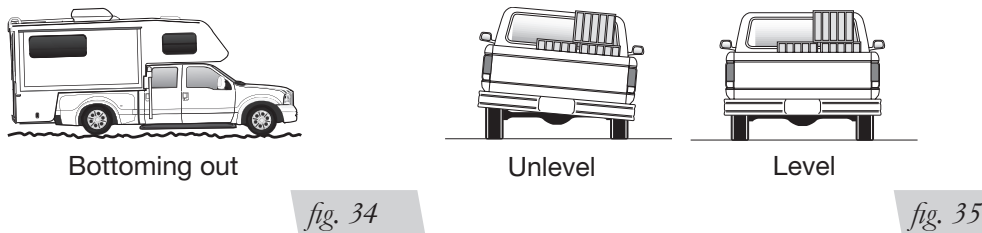
### 3. Stability

Stability translates into safety and should be the priority, meaning the driver may need to sacrifice a perfectly level and comfortable ride. Stability issues include roll control, bounce, dive during braking and sponginess (fig. 33). Tuning out these problems usually requires an increase in pressure.



## GUIDELINES FOR ADDING AIR

1. Start with the vehicle level or slightly above.
2. When in doubt, always add air.
3. If the front of the vehicle dives while braking, increase the pressure in the front air bags, if equipped.
4. If it is ever suspected that the air bags have bottomed out, increase the pressure (fig. 34).
5. Adjust the pressure up and down to find the best ride.
6. If the vehicle rocks and rolls, adjust the air pressure to reduce movement.
7. It may be necessary to maintain different pressures on each side of the vehicle. Loads such as water, fuel, and appliances will cause the vehicle to be heavier on one side (fig. 35). As much as a 50 PSI difference is not uncommon.



# Troubleshooting Guide

PROBLEM	CAUSE	SOLUTION
System won't maintain pressure overnight.	Improperly installed air line, air line has holes or cracks.	Leak test the air line connections, the threaded connection into the air spring, and all fittings in the control system.
Air spring or air line leak.	Fitting seal or air line is compromised.	Check to make sure air lines are seated in connectors. Inspect fittings with soapy water. Trim hose or re-seal fitting. Ensure lines are cut straight.
Corner won't raise or air leak develops.	Look for a kink or fold in the air line.	Replace any air line that has been kinked.

## FREQUENTLY ASKED QUESTIONS

### Q. Will installing air springs increase the weight ratings of a vehicle?

No. Adding air springs will not change the weight ratings (GAWR, GCWR and/or GVWR) of a vehicle. Exceeding the GVWR is dangerous and voids the Air Lift warranty.

### Q. Is it necessary to keep air in the air springs at all times and how much pressure will they need?

For LoadLifter 5000 Ultimate, the recommended minimum air pressure is 5 PSI, but it can safely be run at zero air pressure unladen (no load).

### Q. Is it necessary to add a compressor system to the air springs?

No. Air pressure can be adjusted with any type of compressor as long as it can produce sufficient pressure to service the springs. Even a bicycle tire pump can be used, but it's a lot of work.

### Q. How long should air springs last?

If the air springs are properly installed and maintained they can last indefinitely.

### Q. Will raising the vehicle on a hoist for service work damage the air springs?

No. The vehicle can be lifted on a hoist for short-term service work such as tire rotation or oil changes. However, if the vehicle will be on the hoist for a prolonged period of time, support the axle with jack stands in order to take the tension off of the air springs.

# Notes





# Notes

# Notes

## Limited Warranty and Return Policy

Air Lift Company provides a limited lifetime warranty to the original purchaser of its Load Support products, that the products will be free from defects in workmanship and materials when used on cars and trucks as specified by Air Lift Company and under normal operating conditions, subject to the requirements and exclusions set forth in the full Limited Warranty and Return Policy that is available online at [www.airliftcompany.com/warranty](http://www.airliftcompany.com/warranty).

For additional warranty information contact Air Lift Company customer service.

## Replacement Part Information

If replacement parts are needed, contact the local dealer or call Air Lift customer service at **(800) 248-0892**. Most parts are immediately available and can be shipped the same day.

**Contact Air Lift Company customer service at (800) 248-0892 first if:**

- Parts are missing from the kit.
- Need technical assistance on installation or operation.
- Broken or defective parts in the kit.
- Wrong parts in the kit.
- Have a warranty claim or question.

**Contact the retailer where the kit was purchased:**

- If it is necessary to return or exchange the kit for any reason.
- If there is a problem with shipping if shipped from the retailer.
- If there is a problem with the price.

## Contact Information

<b>Mailing address</b>	P.O. Box 80167 Lansing, MI 48908-0167
<b>Shipping address for returns</b>	2727 Snow Road Lansing, MI 48917
<b>Phone</b>	Toll free: (800) 248-0892 International: (517) 322-2144
<b>Email</b>	<a href="mailto:service@airliftcompany.com">service@airliftcompany.com</a>
<b>Web address</b>	<a href="http://www.airliftcompany.com">www.airliftcompany.com</a>

## Need Help?

Contact Air Lift Company customer service department by calling (800) 248-0892.

For calls from outside the USA or Canada, dial (517) 322-2144.



*Thank you for purchasing Air Lift products — the professional installer's choice!*

Air Lift Company • 2727 Snow Road • Lansing, MI 48917 or P.O. Box 80167 • Lansing, MI 48908-0167  
Toll Free (800) 248-0892 • Local (517) 322-2144 • Fax (517) 322-0240 • [www.airliftcompany.com](http://www.airliftcompany.com)

Printed in the USA  
BGL-0117